

# TECHO—BLOC

INSPIRING ARTSCAPES





# Content

## ■ Bricks and Stone Collections

Brandon	08
Iconic	13

## ■ Stones

Alür	19
Chantilly	20
Madison Grande	22
Madison Various	25

## ■ Bricks

Griffintown	29
Visconti	31

## ■ Architectural Series

Architectural Block	34
LaRoche Stone	39

## ■ Accessories

LaRoche Sill	44
LaRoche Keystone	44

## ■ Technical Specifications

Compatibility Chart	46
Technical Specifications	47
Warranty	54

For an authentic look, each color option is composed of a variety of darker & lighter tones. Natural ingredients are present within the recipe to allow for a range in tones, veining and textures from one stone to another. Color samples for reference only. Actual product colors may vary.

# Breaking the mold

A word from Techo-Bloc's  
founder and president,  
Charles Ciccarello.

As early as I can remember, I was captivated by the work of my father. He was a landscaper, and I had always admired the craft. At that time, I'd see the same brick-style concrete products everywhere I went. No matter how creative we got, we were always limited by the materials. I was hungry for something different and the market was starved of choice.

I started Techo-Bloc as a 26-year-old landscaper with the defiant belief that the landscaping & masonry industry needed some shaking up. This was my main driver and motivator. I became consumed with the idea of manufacturing better concrete products; ones with eye-catching colors and different shapes and sizes. We broke the mold of the beloved brick, and we haven't rested since.

True to form, 2021 denotes another year of change, evolution and pushing the boundaries. We've launched some incredibly avant-garde paving stones, wall designs, masonry products, new technology and revised our packaging to reduce plastic consumption.

Over the years, we've empowered designers, contractors and homeowners with the colors, textures, design ideas and support to create standout statement-making spaces outdoors. However, it's been our creative vision and bold aesthetics that have allowed us to build an incredible community of like-minded individuals that are redefining what is expected of outdoor design.

Every day I am reminded of the responsibility and the great honour Techo-Bloc has in its piece of the puzzle. Thank you for trusting us. Exchanging with us. Inspiring us.



“ We broke the mold of  
the beloved brick, and  
we haven't rested since.”



# Brick and Stone Collection



Beauty and elegance  
at your fingertips

Once again, Techo-Bloc has broken the mold with our Brandon and Iconic collections. The array of color options paired with design combination possibilities, make these two collections nothing less than noteworthy. Customize your home according to your imagination and give free rein to your creativity!

Brandon Brick - Black Pearl



# Brandon T

- Calico  
Available for brick only 
- Shale Grey 
- Davenport Grey  
Available for brick only 
- Sienna Onyx Grey 
- Graphite Grey 
- Black Pearl 



Brandon Brick - Black Pearl

45° Corner Stones  
Height: 3 1/16 in 100 mm

9 1/16 × 11 × 13 3/4  
230 × 280 × 350



Stones  
Height: 3 1/16 in 100 mm

9 1/16 × 9 1/16  
230 × 230



9 1/16 × 13 3/4  
230 × 250



Brandon Brick and Stone - Shale Grey

45° Corner Stones  
Height: 3 3/16 in 90 mm

4 5/16 × 6 5/16 × 9 1/16  
110 × 160 × 230



4 5/16 × 8 1/16 × 11 7/16  
110 × 220 × 290



4 5/16 × 11 × 13 3/4  
110 × 280 × 350



4 5/16 × 4 5/16  
110 × 110



4 5/16 × 6 1/16  
110 × 170



4 5/16 × 9 1/16  
110 × 230



4 5/16 × 11 7/16  
110 × 290



4 5/16 × 13 3/4  
110 × 350



Brick  
Height: 3 3/16 in 90 mm



Technical specifications on page 50

⑤ Iconic



Tints of Vanilla



Silver Waves



Volcanic Black  
Black mortar is recommended

Iconic Brick and Stone - Timeless Pattern - Tints of Vanilla

Stones

Height: 3 3/16 in 90 mm

6 5/8 x 17 3/8  
168 x 448

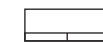
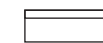

6 5/8 x 23 3/8  
168 x 600

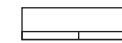
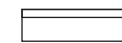

6 5/8 x 29 3/8  
168 x 752

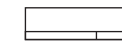
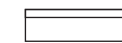

Bricks

Height: 3 3/16 in 90 mm

3 1/8 x 23 3/8  
79 x 600

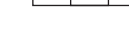
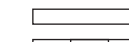

## Patterns

Combining the Iconic stone and brick creates a bold and distinguished effect. Its multiple layouts denote its versatility and it is compatible with all styles of architecture. Iconic's various arrangements will undoubtedly fit perfectly with your taste and become the emblem of your home.

### Luxurious

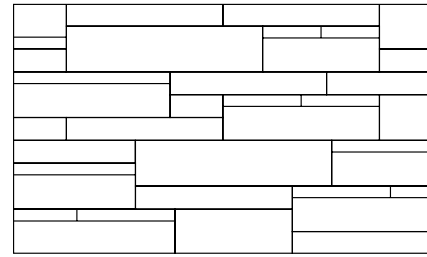

60% Stones, 40% Bricks

### Balanced

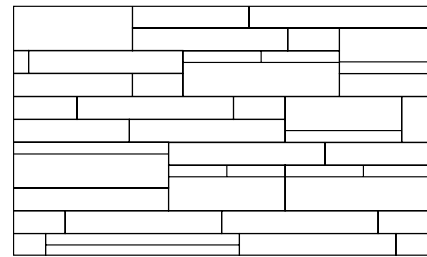

50% Stones, 50% Bricks

### Timeless

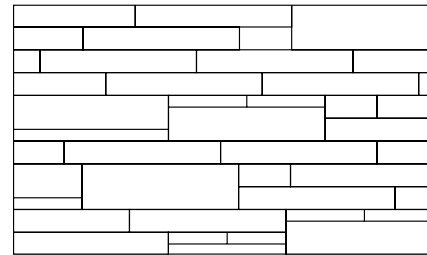

40% Stones, 60% Bricks

### Urban

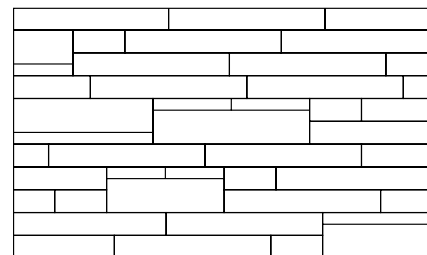

30% Stones, 70% Bricks



Iconic Brick and Stone - Timeless Pattern - Tints of Vanilla



# Stones

---

Build up to something beautiful.

Both elegant and classic, stone masonry is the perfect way to complement the unique character of your home. Its natural stone appeal will bring originality and boldness to the exterior of your residence. Let the combination of brawn and beauty add a look to your home that will transcend time.

Alür Stone - Sienna Onyx Grey



Technical specifications on page 47

Ⓣ Alür



Alür Stone - Davenport Grey



Alür Stone - Davenport Grey



Calico



Davenport Grey



Sienna Onyx Grey

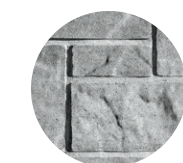

Graphite Grey

Stones

Height: 3 1/16 in 100 mm

3 1/2 x 4 1/4 89 x 108	3 1/2 x 9 89 x 229	3 1/2 x 13 3/4 89 x 349	3 1/2 x 18 1/2 89 x 470	7 1/2 x 9 191 x 229	7 1/2 x 13 3/4 89 x 349	7 1/2 x 18 1/2 89 x 470	11 1/2 x 13 3/4 292 x 349	11 1/2 x 18 1/2 292 x 470

Stones

Height: 4 1/16 in 125 mm

8 x 6 230 x 152

45° Corner

Height: 3 1/16 in 100 mm

3 1/2 x 9 1/16 x 12 89 x 250 x 305	3 1/2 x 15 1/16 x 18 89 x 402 x 457	7 1/2 x 9 1/16 x 12 191 x 250 x 305	7 1/2 x 15 1/16 x 18 191 x 402 x 457	11 1/2 x 9 1/16 x 12 292 x 250 x 305	11 1/2 x 15 1/16 x 18 292 x 402 x 457

# Chantilly S

Sahara Beige



Hacienda



Hacienda Light



Victoria



Chantilly Stone - Victoria



Chantilly Stone - Hacienda Light

45° Corners  
Height: 3 1/4 in 100 mm

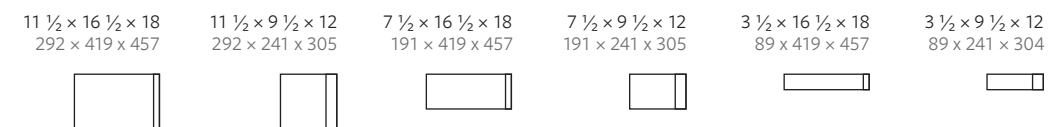

Candle  
Height: 4 5/8 in 110 mm

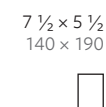

Stones  
Height: 3 1/4 in 100 mm

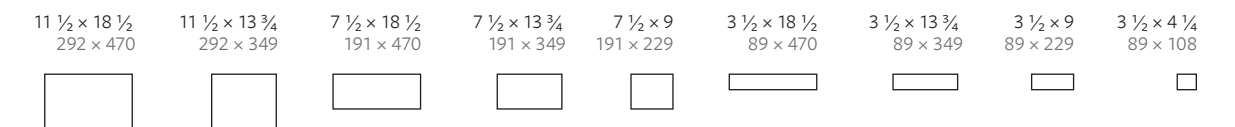

# Madison T

## Grande

Smooth

Slate

Urban White



Platinum Grey



Sienna Onyx Grey



Graphite Grey



Madison Grande Stone Slate - Sienna Onyx Grey



Grande

Height: 3 3/16 in 90 mm

9 1/16 x 15 3/4  
230 x 400



9 1/16 x 17 1/16  
230 x 450



9 1/16 x 19 1/16  
230 x 500



9 1/16 x 21 3/8  
230 x 550



9 1/16 x 23 3/8  
230 x 600



9 1/16 x 25 3/16  
230 x 650



Technical specifications on page 53

**T** Madison  
Various

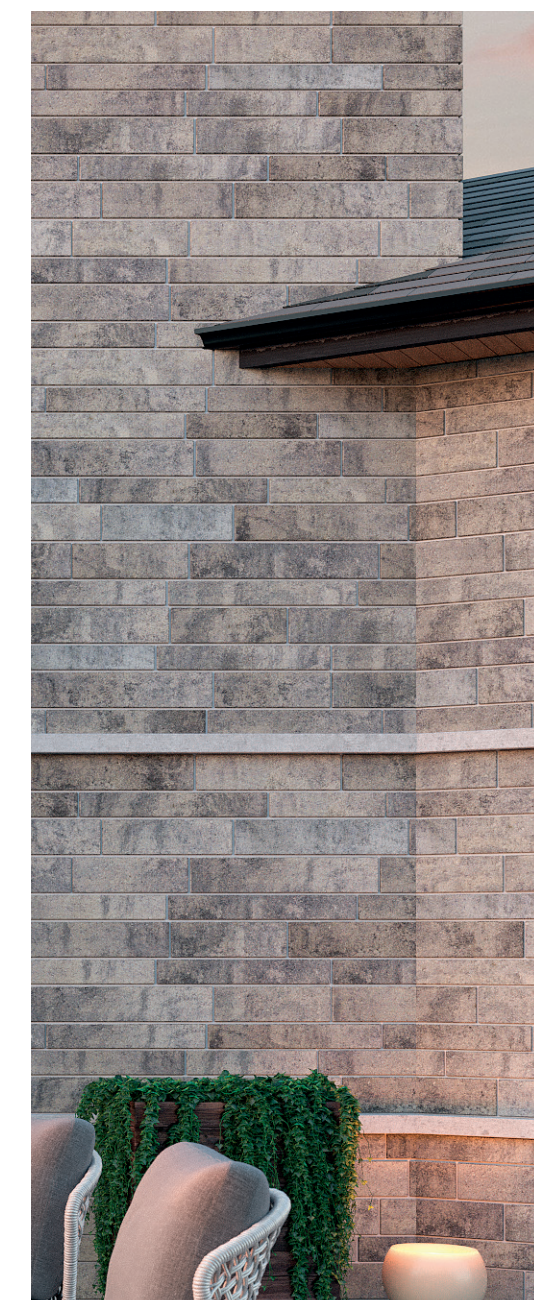













Smooth	Slate	
		Urban White
		Platinum Grey
		Sienna Onyx Grey
		Graphite Grey

Madison Various Stone Smooth - Graphite Grey

Various Sizes

Height: 3 3/16 in 90 mm

3 3/16 × 15 3/4 90 x 400 	3 3/16 × 17 1/16 90 x 450 	3 3/16 × 19 1/16 90 x 500 	3 3/16 × 21 5/8 90 x 550 	3 3/16 × 23 5/8 90 x 600 	3 3/16 × 25 3/16 90 x 650 
5 1/8 × 15 3/4 130 x 400 	5 1/8 × 17 1/16 130 x 450 	5 1/8 × 19 1/16 130 x 500 	5 1/8 × 21 5/8 130 x 550 	5 1/8 × 23 5/8 130 x 600 	5 1/8 × 25 3/16 130 x 650 

# Bricks

---

## Taking curb appeal to new heights.

From modern to traditional, our collection of bricks has something for everyone. Choose from straight and clean lines or rough-hewn classics to customize your home to your unique style. They are guaranteed to complement the design and aesthetic of any home, making them the ideal masonry choice for your exterior project.

Griffintown Brick - Elegant White (on order only)



Technical specifications on page 50

# Ⓣ Griffintown



Griffintown Brick - Elegant White (on order only)



Griffintown Brick - Graphite Grey



Calico



Satin Grey



Champlain Grey



Graphite Grey



Black Pearl

Brick

Height: 3 1/2 in 90 mm

3 1/8 x 10 1/8  
79 x 257



Technical specifications on page 53

# Ⓣ Visconti



Visconti Brick - Black Pearl et Shale Grey



Visconti Brick - Black Pearl et Shale Grey



Shale Grey



Champlain Grey



Graphite Grey

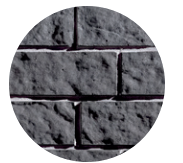

Black Pearl

Brick

Height: 3 3/16 in 90 mm

3 1/16 x 12 3/8  
100 x 320



Corner

Height: 3 3/16 in 90 mm

3 1/16 x 12 3/8 x 12 3/8  
100 x 320 x 315





# Architectural Series

## The building blocks of style.

These oversized and larger than life blocks are amongst our most diverse masonry offerings. Our Architectural Block and LaRochelle collection provide you with trendy colors and larger than life textures so you can let your creativity run wild. These out-of-the-box beauties will allow you to fully customize your curb appeal for a jaw-dropping home.

LaRochelle Stone 12x24 Grinded - Elegant White



# Architectural Block <sup>®</sup>

	Smooth Available for 8 x 16 only	Polished	Granitex	Grinded	Split Face Available for 8 x 16 only	
Light Amber Brown						Standard Colors
Elegant White						
Nickel						
Grey						
Carbon						
Pure White						Elite Colors (on order)
Onyx Black						

Block 4 x 16  
Height: 3 3/8 in 90 mm

3 3/8 x 15 3/8  
90 x 390



Block 8 x 16  
Height: 3 3/8 in 90 mm

7 1/2 x 15 3/8  
190 x 390



Architectural Block 8x16 Smooth - Elegant White



LaRochelle Stone - Grinded Grey



LaRochelle Stone - Polished Elegant White

Technical specifications on page 51

# Ⓣ LaRoche Stone



Griffintown Brick - Elegant White and LaRoche Stone 4 x 24 and 8 x 24 Grinded - Carbon

	Smooth Available for 8 x 24 & 12 x 24 only	Polished	Granitex	Grinded	Split Face Available for Sill only	
Standard Colors						Light Amber Brown
						Elegant White
						Nickel
						Grey
						Carbon
Elite Colors (on order)						Pure White
						Onyx Black

Brick Height: 3 3/16 in 90 mm 3 3/16 x 11 7/16 90 x 290	Corner Brick Height: 3 3/16 in 90 mm 3 3/16 x 11 7/16 90 x 290	Stone 4 x 24 Height: 3 3/16 in 90 mm 3 3/16 x 23 1/4 90 x 590	Stone 6 x 24 Height: 3 3/16 in 90 mm 5 1/2 x 23 1/4 140 x 590	Stone 8 x 24 Height: 3 3/16 in 90 mm 7 1/2 x 23 1/4 190 x 590	Stone 12 x 24 Height: 3 3/16 in 90 mm 11 3/8 x 23 1/4 390 x 590
--	---	--	--	--	--

Sill Height: 3 3/16 in 90 mm 5 1/16 x 23 1/4 145 x 590	Keystone Height: 3 3/16 in 90 mm 11 7/16 x 6 x 8 290 x 152 x 203
---	---



LaRochelle Stone 12 x 24 Grinded - Pure White

# Accessories —

## The final touches to your home transformation

Your home transformation is almost complete. You've thought of everything, except masonry accessories. Don't worry, we've got you covered. We offer a window sill and keystone design that will help you bring your home project vision to life. Final touches are key to any successful project. Thankfully, we've thought of every last detail.





Architectural Block 8x16 - Smooth Elegant White - LaRoche Sill Split Face - Elegant White

## LaRoche Sill

The Techo-Bloc window sills come in 7 shades and 5 textures that pair beautifully with our LaRoche stones and architectural blocks, allowing you to bring your home project vision to life. Our sills will also add elegance and finesse to all our ranges of masonry products.

Texture without Chamfer

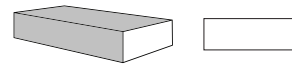

Texture with Chamfer

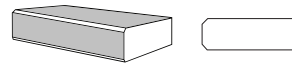

Split Face without Chamfer

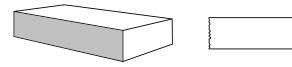

Technical specifications on page 52

## LaRoche Keystone

Our keystones are available in 7 shades and 3 textures. In addition, you can choose whether you want your Keystone with or without chamfer to match your design needs.

Texture without Chamfer

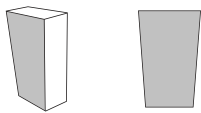

Texture with Chamfer

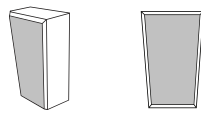

Technical specifications on page 52

Architectural Block - Nickel Grinded  
LaRoche Candle/Lintel - Nickel Grinded  
LaRoche Sill - Nickel Grinded



Chantilly Stone - Victoria

	Bricks					Stones								Blocks		Acc.			
	Brandon	Griffintown	Iconic	Triana	Visconti	Alür	Brandon	Chantilly	Iconic	LaRochelle 4 x 24	LaRochelle 6 x 24	LaRochelle 8 x 24	LaRochelle 12 x 24	Madison Grande	Madison Various	Architectural Block 4 x 16	Architectural Block 8 x 16	LaRochelle Sill	LaRochelle Keystone
<b>Bricks</b>																			
Brandon	x					x	x	x		x	x	x	x	x	x	x	x	x	x
Griffintown		x				x		x	x	x	x	x	x	x	x	x	x	x	x
Iconic			x						x	x	x	x	x			x	x	x	x
Visconti					x	x		x		x	x	x	x	x	x	x	x	x	x
<b>Stones</b>																			
Alür	x	x		x	x	x			x	x	x	x			x	x	x	x	
Brandon	x						x		x	x	x	x			x	x	x	x	
Chantilly	x	x	x	x	x			x	x	x	x	x			x	x	x	x	
Iconic		x	x						x	x	x	x			x	x	x	x	
LaRochelle 4 x 24	x	x	x	x	x	x	x	x	x	x	x	x	x	x	x	x	x	x	
LaRochelle 6 x 24	x	x	x	x	x	x	x	x	x	x	x	x	x	x	x	x	x	x	
LaRochelle 8 x 24	x	x	x	x	x	x	x	x	x	x	x	x	x	x	x	x	x	x	
LaRochelle 12 x 24	x	x	x	x	x	x	x	x	x	x	x	x	x	x	x	x	x	x	
Madison Grande	x	x		x	x				x	x	x	x		x	x	x	x	x	
Madison Various	x	x		x	x				x	x	x	x		x	x	x	x	x	
<b>Blocks</b>																			
Architectural Block 4 x 16	x	x	x	x	x	x	x	x	x	x	x	x	x	x	x	x	x	x	
Architectural Block 8 x 16	x	x	x	x	x	x	x	x	x	x	x	x	x	x	x	x	x	x	
<b>Accessories</b>																			
LaRochelle Sill	x	x	x	x	x	x	x	x	x	x	x	x	x	x	x	x	x	x	
LaRochelle Keystone	x	x	x	x	x	x	x	x	x	x	x	x	x	x	x	x	x	x	

NOTE: The combinations shown in this chart are not complete. Other possible combinations exist.

## Alür





**Stones**

Sold by full pallet

CUBING  
7,21 m<sup>2</sup> / 77,65 ft<sup>2</sup> per pallet  
1,03 m<sup>2</sup> / 11,09 ft<sup>2</sup> per row  
1 385 kg / 3053 lbs  
126 units  
7 row of 18 units

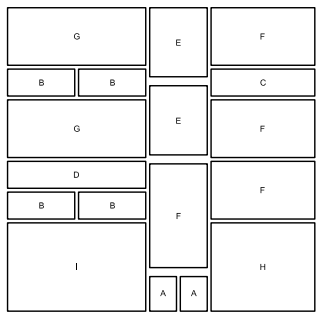
A-B-C-D = 19% / E-F-G = 56% / H-I = 25%







**A - 2% (14 units/pallet)**  
100 x 89 x 108mm  
3 15/16 x 3 1/2 x 4 1/4 in



**B - 9% (28 units/pallet)**  
100 x 89 x 229mm  
3 15/16 x 3 1/2 x 9 in



**C - 3% (7 units/pallet)**  
100 x 89 x 349mm  
3 15/16 x 3 1/2 x 13 3/4 in



**D - 5% (7 units/pallet)**  
100 x 89 x 470mm  
3 15/16 x 3 1/2 x 18 1/2 in



**E - 9% (14 units/pallet)**  
100 x 191 x 229mm  
3 15/16 x 7 1/2 x 9 in



**F - 28% (28 units/pallet)**  
100 x 191 x 349mm  
3 15/16 x 7 1/2 x 13 3/4 in



**G - 19% (14 units/pallet)**  
100 x 191 x 470mm  
3 15/16 x 7 1/2 x 18 1/2 in

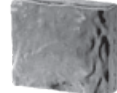

**H - 11% (7 units/pallet)**  
100 x 292 x 349mm  
3 15/16 x 11 1/2 x 13 3/4 in

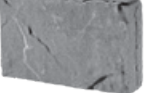

**I - 14% (7 units/pallet)**  
100 x 292 x 470mm  
3 15/16 x 11 1/2 x 18 1/2 in

---

**Stones / 45° Corners**

Sold by full pallet or row

CUBING  
10,99 lin. m / 36,04 lin. ft per pallet  
2,20 lin. m / 7,21 lin. ft per row  
789 kg / 1739 lbs  
70 units  
5 row of 14 units

A-B = 36% / C-D = 37% / E-F = 27%

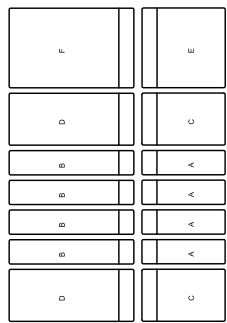





**A - 29% (20 units/pallet)**  
100 x 89 x 250 x 305mm  
3 15/16 x 3 1/2 x 9 13/16 x 12 in



**B - 29% (20 units/pallet)**  
100 x 89 x 402 x 457mm  
3 15/16 x 3 1/2 x 15 13/16 x 18 in



**E - 7% (5 units/pallet)**  
100 x 292 x 250 x 305mm  
3 15/16 x 11 1/2 x 9 13/16 x 12 in



**F - 7% (5 units/pallet)**  
100 x 292 x 402 x 457mm  
3 15/16 x 11 1/2 x 15 13/16 x 18 in



**C - 14% (10 units/pallet)**  
100 x 191 x 250 x 305mm  
3 15/16 x 7 1/2 x 9 13/16 x 12 in





**D - 14% (10 units/pallet)**  
100 x 191 x 402 x 457mm  
3 15/16 x 7 1/2 x 15 13/16 x 18 in

**Stones / Candle**

Sold by full pallet or row

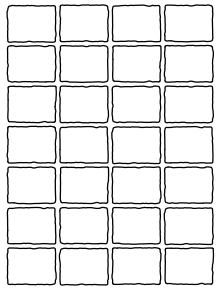
CUBING  
1383 kg / 3050 lbs  
168 units  
6 row of 28 units





**V - 125 x 152 x 203 mm**  
4 15/16 x 6 x 8 in



# Architectural Block



**Block 4 x 16** Sold by unit

CUBING  
8,41 m<sup>2</sup> / 90,42 ft<sup>2</sup> per pallet  
24,96 units per m<sup>2</sup> / 2,32 units per ft<sup>2</sup>  
1143 kg / 2520 lbs (Onyx Black 1493 kg/3292 lbs)  
210 units  
7 row of 30 units



90 x 90 x 390 mm  
3 3/16 x 3 3/16 x 15 3/8 in

TEXTURES (SEE PAGE 38)  
Granitex  
Polished  
Grinded

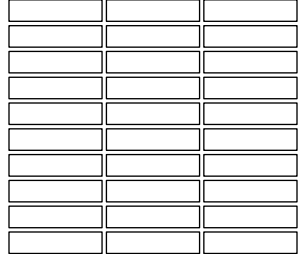

**Block 8 x 16** Sold by unit

CUBING  
8,40 m<sup>2</sup> / 90,42 ft<sup>2</sup> per pallet  
12,50 units per m<sup>2</sup> / 1,16 units per ft<sup>2</sup>  
1143 kg / 2520 lbs (Onyx Black 1524 kg / 3360 lbs)  
105 units  
7 row of 15 units



90 x 190 x 390 mm  
3 3/16 x 7 1/2 x 15 3/8 in

TEXTURES (SEE PAGE 38)  
Granitex  
Smooth  
Polished  
Grinded

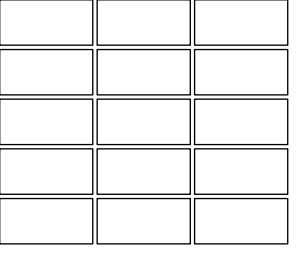

**Block Split Face 4 x 16** Sold by full pallet

CUBING  
8,40 m<sup>2</sup> / 62 ft<sup>2</sup> per pallet  
12,50 units per m<sup>2</sup> / 1,16 units per ft<sup>2</sup>  
970 kg / 2138 lbs (Onyx Black 1294 kg / 2853 lbs)  
72 units (12 corner units)  
3 row of 24 units



90 x 190 x 390 mm  
3 3/16 x 7 1/2 x 15 3/8 in

TEXTURES (SEE PAGE 38)  
Split Face

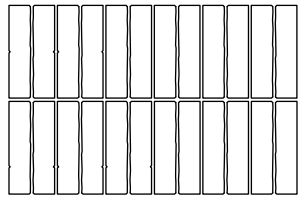

**Sales conditions**

- A minimum order of 3,000 units is required for Elite colors.
- Check availability with our customer service or your representative.
- All orders must be picked up or delivered within 30 days of the confirmed delivery date..
- The order is considered final 24 hours after it is received at Techo-Bloc. No changes will be accepted after 24 hours.
- The order cannot be cancelled. The customer is responsible for the entire order.
- The bevel is 3/8" dimension.
- The bevel have a grinded finish.
- The split face texture is only available for the following format : 90 x 190 x 390 mm (3,54 x 7,48 x 15,35 in.).

# Brandon



**Bricks** Sold by full pallet

CUBING  
8,88 m<sup>2</sup> / 95,60ft<sup>2</sup> per pallet  
1,11 m<sup>2</sup> / 11,95 ft<sup>2</sup> per row  
1616 kg / 3563 lbs  
288 units  
8 row of 36 units

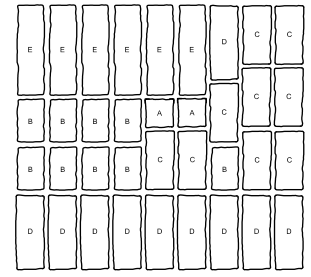

**A - 2% (16 units/pallet)**  
90 x 110 x 110 mm  
3 3/16 x 4 3/16 x 4 3/16 in

**B - 17% (72 units/pallet)**  
90 x 110 x 170 mm  
3 3/16 x 4 3/16 x 6 1/16 in

**C - 24% (72 units/pallet)**  
90 x 110 x 230 mm  
3 3/16 x 4 3/16 x 9 1/16 in

**D - 33% (80 units/pallet)**  
90 x 110 x 290 mm  
3 3/16 x 4 3/16 x 11 3/16 in

**E - 24% (48 units/pallet)**  
90 x 110 x 350 mm  
3 3/16 x 4 3/16 x 13 3/16 in

**Bricks / 45° Corners** Sold by full pallet or row

CUBING  
12,50 lin. m / 41 lin. ft per pallet  
3,12 lin. m / 10,23 lin. ft per row  
665 kg / 1467 lbs  
104 units  
4 row of 26 units

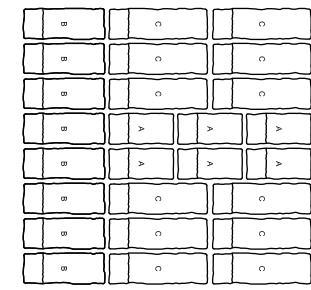

**A - 18% (24 units/pallet)**  
90 x 110 x 160 x 230mm  
3 3/16 x 4 3/16 x 6 1/16 x 9 1/16 in

**B - 29% (32 units/pallet)**  
90 x 110 x 220 x 290mm  
3 3/16 x 4 3/16 x 8 1/16 x 11 3/16 in

**C - 53% (48 units/pallet)**  
90 x 110 x 280 x 350mm  
3 3/16 x 4 3/16 x 11 x 13 3/16 in

**Stones** Sold by full pallet

CUBING  
8,29 m<sup>2</sup> / 89,28 ft<sup>2</sup> per pallet  
1,04 m<sup>2</sup> / 11,16 ft<sup>2</sup> per row  
1 616 kg / 3563 lbs  
120 units  
8 row of 15 units

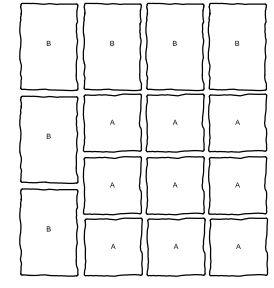

**A - 50% (72 units/pallet)**  
100 x 230 x 230 mm  
3 15/16 x 9 1/16 x 9 1/16 in

**B - 50 % (48 units/pallet)**  
100 x 230 x 350 mm  
3 15/16 x 9 1/16 x 13 3/4 in

**Stones / 45° Corners** Sold by full pallet or row

CUBING  
11,52 lin. m / 37,80 lin. ft per pallet  
2,88 lin. / 9,45 lin. ft per row  
774kg / 1706 lbs  
48 units  
4 row of 12 units

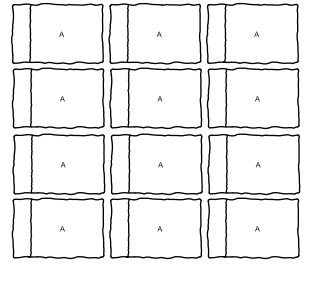

100 x 230 x 280 x 350mm  
3 15/16 x 9 1/16 x 11 x 13 3/4 in

# Chantilly



**Stones** Sold by full pallet

CUBING  
5,69 m<sup>2</sup> / 61,24 ft<sup>2</sup> per pallet  
0,948 m<sup>2</sup> / 10,206 ft<sup>2</sup> per row  
1102 kg / 2430 lb  
96 units  
6 row of 16 units  
A-B-C-D=20% / E-F-G=53% / H-I=27%

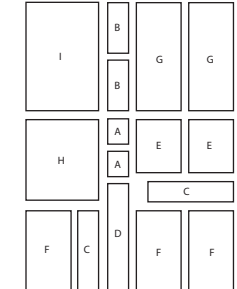

**A - (12 units/pallet)**  
100 x 89 x 108mm  
3 15/16 x 3 1/2 x 4 1/4 in

**B - (12 units/pallet)**  
100 x 89 x 229mm  
3 15/16 x 3 1/2 x 9 in

**C - (12 units/pallet)**  
100 x 89 x 349mm  
3 15/16 x 3 1/2 x 13 3/4 in

**D - (6 units/pallet)**  
100 x 89 x 470mm  
3 15/16 x 3 1/2 x 18 1/2 in

**E - (12 units/pallet)**  
100 x 191 x 229mm  
3 15/16 x 7 1/2 x 9 in

**F - (18 units/pallet)**  
100 x 191 x 349mm  
3 15/16 x 7 1/2 x 13 3/4 in

**G - (12 units/pallet)**  
100 x 191 x 470mm  
3 15/16 x 7 1/2 x 18 1/2 in

**H - (6 units/pallet)**  
100 x 292 x 349mm  
3 15/16 x 11 1/2 x 13 3/4 in

**I - (6 units/pallet)**  
100 x 292 x 470mm  
3 15/16 x 11 1/2 x 18 1/2 in

**Stones / 45° Corners**

Sold by full pallet or row

CUBING  
9,61 lin. m / 31,54 lin. ft per pallet  
2,403 lin. m / 7,884 lin. ft per row  
816 kg / 1800 lb  
52 units  
4 row of 13 units  
A-B=18% / C-D=44% / E-F=38%

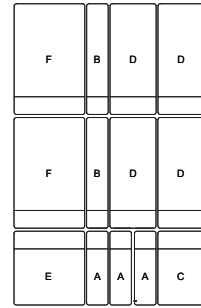

**A- 9% (12 units/pallet)**  
100 x 88 x 241 x 304mm  
3 1/16 x 3 1/2 x 9 1/2 x 12 po

**B- 9% (8 units/pallet)**  
100 x 89 x 419 x 457mm  
3 1/16 x 3 1/2 x 16 1/2 x 18 po

**C- 6% (4 units/pallet)**  
100 x 191 x 241 x 305mm  
3 1/16 x 7 1/2 x 9 1/2 x 12 po

**D- 38% (16 units/pallet)**  
100 x 191 x 419 x 457mm  
3 1/16 x 7 1/2 x 16 1/2 x 18 po

**E- 10% (4 units/pallet)**  
100 x 292 x 241 x 305mm  
3 1/16 x 11 1/2 x 9 1/2 x 12 po

**F- 28% (8 units/pallet)**  
100 x 292 x 419 x 457mm  
3 1/16 x 11 1/2 x 16 1/2 x 18 po

**Stones / Candle**

Sold by full pallet or row

CUBING  
1067 kg / 2353 lb  
120 units  
5 row of 24 units

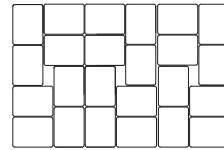

**127 x 160 x 203 mm**  
5 x 6 1/16 x 8 in

**Griffintown**

**Brick**

Sold by full pallet

CUBING  
8,36 m² / 90,04 ft² per palet  
1,05 m² / 11,25 ft² per row  
42,08 units per m² / 3,91 units per pi²  
1275 kg / 2811 lb  
352 units  
8 row of 44 units  
Unit A : 288 units/palet  
Unit B : 64 units/palet

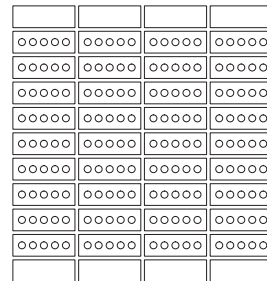

**A- 82% (36 units/row)**  
90x 79x 257 mm  
3 1/2 x 3 1/8 x 10 1/8 in

**B- 18% (8 units/row)**  
90x 79x 257 mm  
3 1/2 x 3 1/8 x 10 1/8 in

**Iconic**

**Bricks**

Sold by full pallet

CUBING  
8,40 m² / 90,38 ft² par palette  
1,20 m² / 12,91 ft² par rang  
18,34 units per m² / 1,70 units per ft²  
1461 kg / 3220 lb  
154 units  
7 row of 22 units

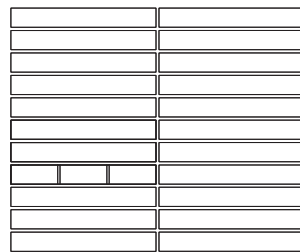

**A- 95% (147 units/pal)**  
90 x 79 x 600mm  
3 3/16 x 3 1/8 x 23 3/8 in

**B- 5% (7 units/pal)**  
90 x 79 x 600mm  
3 3/16 x 3 1/8 x 23 3/8 in

**Stones**

Sold by full pallet

CUBING  
6,09 m² / 65,56 ft² per pallet  
0,874 m² / 9,37 ft² per row  
1 125 kg / 2481 lbs  
56 units  
7 row of 8 units

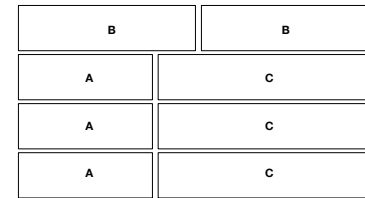

**A- 28% (21 units/pallet)**  
90 x 168 x 448 mm  
3 3/16 x 6 5/8 x 17 3/8 in

**B- 25% (14 units/pallet)**  
90 x 168 x 600mm  
3 3/16 x 6 5/8 x 23 3/8 in

**C- 47% (21 units/pallet)**  
90 x 168 x 752 mm  
3 3/16 x 6 5/8 x 29 3/8 in

**LaRochele**

**Stone 4 x 24**

Sold by unit

CUBING  
140 units / 7 row of 20 units  
1474 kg / 3250 lbs  
11 kg / 24,35 lbs per unit  
**Onyx Black**  
2072 kg / 4568 lbs  
14,7 kg / 32,34 lbs per unit

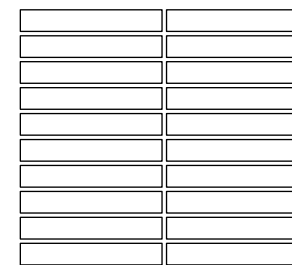

**90 x 90 x 590 mm**  
3 3/16 x 3 3/16 x 23 1/4 in

TEXTURES (SEE PAGE 43)  
Granitex  
Polished  
Grinded

**Stone 6 x 24**

Sold by unit

CUBING  
84 units / 7 row of 12 units  
1440 kg / 3175 lbs  
17 kg / 37,5 lbs per unit  
**Onyx Black**  
1866 kg / 4114 lbs  
22 kg / 48,50 lbs per unit

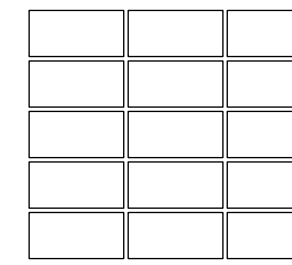

**90 x 140 x 590 mm**  
3 3/16 x 5 1/2 x 23 1/4 in

TEXTURES (SEE PAGE 43)  
Granitex  
Smooth  
Polished  
Grinded

**Stone 8 x 24**

Sold by unit

CUBING  
70 units / 7 row of 10 units  
1633 kg / 3600 lbs  
22 kg / 48,50 lbs per unit  
**Onyx Black**  
2048 kg / 4515 lbs  
29 kg / 63,93 lbs per unit

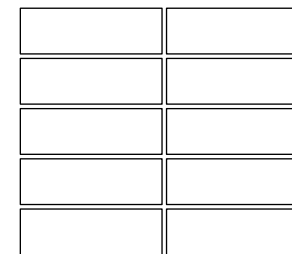

**90 x 190 x 590 mm**  
3 3/16 x 7 1/2 x 23 1/4 in

TEXTURES (SEE PAGE 43)  
Granitex  
Smooth  
Polished  
Grinded

**Stone 12 x 24**

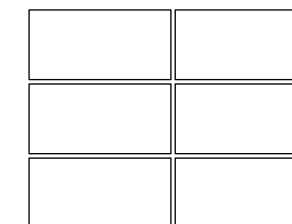

Sold by unit

CUBING  
42 units / 7 row of 6 units  
1440 kg / 3172 lbs  
34 kg / 75 lbs per unit  
**Onyx Black**  
1866 kg / 4114 lbs  
44 kg / 97 lbs per unit



**90 x 290 x 590 mm**  
3 3/16 x 11 3/16 x 23 1/4 in

TEXTURES (SEE PAGE 43)  
Granitex  
Smooth  
Polished  
Grinded

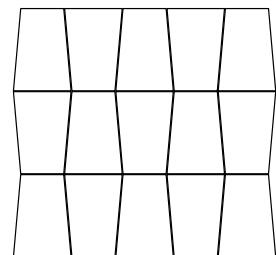

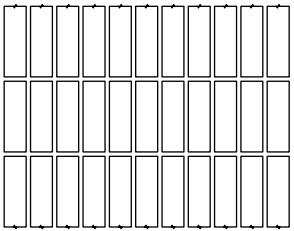
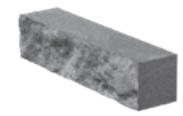
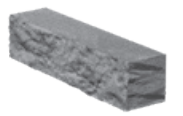



Sill	Sold by unit	Keystone	Sold by unit														
<p>CUBING</p> <p>49,55 lin. m / 162,54 lin. ft per pallet</p> <p>84 units / 7 row of 12 units</p> <p>1403 kg / 3094 lbs</p> <p>17,40 kg / 38,36 lbs per unit</p> <p><b>Onyx Black</b></p> <p>1849 kg / 4077 lbs</p> <p>21,80 kg / 48,06 lbs per unit</p>	 <p>145 x 90 x 590 mm</p> <p>5 1/16 x 3 3/16 x 23 1/4 in</p>	<p>CUBING</p> <p>105 units / 7 row of 15 units</p> <p>1176 kg / 2592 lbs</p> <p>10,59 kg / 23,35 lbs per unit</p> <p><b>Onyx Black</b></p> <p>1428 kg / 3148 lbs</p> <p>13 1/2 kg / 29,76 lbs per unit</p>	 <p>90 x 290 x 152 x 203mm</p> <p>3 3/16 x 11 7/16 x 6 x 8 in</p>														
<table border="1"> <tr><td> </td><td> </td></tr> <tr><td> </td><td> </td></tr> <tr><td> </td><td> </td></tr> <tr><td> </td><td> </td></tr> <tr><td> </td><td> </td></tr> <tr><td> </td><td> </td></tr> <tr><td> </td><td> </td></tr> </table>															<p>TEXTURES (SEE PAGE 48)</p> <p>Split Face</p> <p>Granitex</p> <p>Polished</p> <p>Grinded</p>		<p>TEXTURES (SEE PAGE 48)</p> <p>Granitex</p> <p>Polished</p> <p>Grinded</p>

Bricks	Sold by full pallet	TEXTURES
<p>CUBING</p> <p>7,92 m<sup>2</sup> / 85,25 ft<sup>2</sup> per pallet</p> <p>0,99 m<sup>2</sup> / 10,66 ft<sup>2</sup> per row</p> <p>33,33 units per m<sup>2</sup> / 3,10 units per ft<sup>2</sup></p> <p>1395 kg / 3076 lbs</p> <p>264 units</p> <p>8 row of 33 units</p>		<p>Granitex</p> <p>Polished</p> <p>Grinded</p>
	 <p><b>Regular - 33% (88 units/pallet)</b></p> <p>90 x 90 x 290 mm</p> <p>3 3/16 x 3 3/16 x 11 7/16 in</p>	
	 <p><b>Corner - 67% (176 units/pallet)</b></p> <p>90 x 90 x 290 x 285 mm</p> <p>3 3/16 x 3 3/16 x 11 7/16 x 11 1/4 in</p>	

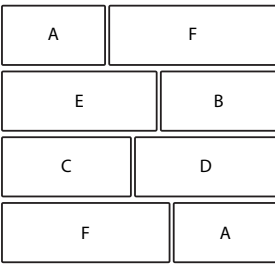









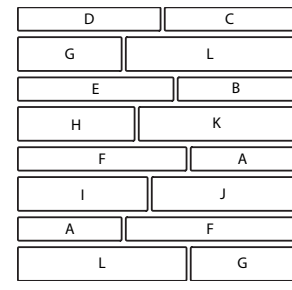

Sales conditions / Stones, Sills and Keystones

- A minimum order of 3,000 units is required for Elite colors.
- Check availability with our customer service or your representative.
- All orders must be picked up or delivered within 30 days of the confirmed delivery date.
- The order is considered final 24 hours after it is received at Techo-Bloc. No changes will be accepted after 24 hours.
- The order cannot be cancelled. The customer is responsible for the entire order.
- The bevel is 3/8" dimension.
- The bevel have a grinded finish.
- The split face texture is only available for the following format: 90 x 190 x 390 mm (3,54 x 7,48 x 15,35 in.).



## Madison Grande

Stones	Sold by full pallet
<p>CUBING</p> <p>7,19m<sup>2</sup> / 77,40 ft<sup>2</sup> per pallet</p> <p>1,03 m<sup>2</sup> / 11,06 ft<sup>2</sup> per row</p> <p>1420 kg / 3130 lbs</p> <p>56 units</p> <p>7 row of 8 units</p>	
	 <p><b>A - 19% (14 units/pallet)</b></p> <p>90 x 230 x 400 mm</p> <p>3 3/16 x 9 1/16 x 15 3/4 in</p>
	 <p><b>B - 11% (7 units/pallet)</b></p> <p>90 x 230 x 450 mm</p> <p>3 3/16 x 9 1/16 x 17 11/16 in</p>
	 <p><b>C - 12% (7 units/pallet)</b></p> <p>90 x 230 x 500 mm</p> <p>3 3/16 x 9 1/16 x 19 11/16 in</p>
	 <p><b>D - 13% (7 units/pallet)</b></p> <p>90 x 230 x 550 mm</p> <p>3 3/16 x 9 1/16 x 21 5/8 in</p>
	 <p><b>E - 14% (7 units/pallet)</b></p> <p>90 x 230 x 600 mm</p> <p>3 3/16 x 9 1/16 x 23 5/8 in</p>
	 <p><b>F - 31% (14 units/pallet)</b></p> <p>90 x 230 x 650 mm</p> <p>3 3/16 x 9 1/16 x 25 5/8 in</p>

## Madison Various

Stones	Sold by full pallet
<p>CUBING</p> <p>7,19m<sup>2</sup> / 77,40 ft<sup>2</sup> per pallet</p> <p>1,03 m<sup>2</sup> / 11,06 ft<sup>2</sup> per row</p> <p>1380 kg / 3042 lbs</p> <p>112 units</p> <p>7 row of 16 units</p>	
	 <p><b>A - 8% (14 units/pallet)</b></p> <p>90 x 90 x 400 mm</p> <p>3 3/16 x 3 3/16 x 15 3/4 in</p>
	 <p><b>B - 4% (7 units/pallet)</b></p> <p>90 x 90 x 450 mm</p> <p>3 3/16 x 3 3/16 x 17 11/16 in</p>
	 <p><b>C - 5% (7 units/pallet)</b></p> <p>90 x 90 x 500 mm</p> <p>3 3/16 x 3 3/16 x 19 11/16 in</p>
	 <p><b>D - 5% (7 units/pallet)</b></p> <p>90 x 90 x 550 mm</p> <p>3 3/16 x 3 3/16 x 21 5/8 in</p>
	 <p><b>E - 6% (7 units/pallet)</b></p> <p>90 x 90 x 600 mm</p> <p>3 3/16 x 3 3/16 x 23 5/8 in</p>
	 <p><b>F - 13% (14 units/pallet)</b></p> <p>90 x 90 x 650 mm</p> <p>3 3/16 x 3 3/16 x 25 5/8 in</p>
	 <p><b>G - 11% (14 units/pallet)</b></p> <p>90 x 130 x 400 mm</p> <p>3 3/16 x 5 1/8 x 15 3/4 in</p>
	 <p><b>H - 6% (7 units/pallet)</b></p> <p>90 x 130 x 450 mm</p> <p>3 3/16 x 5 1/8 x 17 11/16 in</p>
	 <p><b>I - 7% (7 units/pallet)</b></p> <p>90 x 130 x 500 mm</p> <p>3 3/16 x 5 1/8 x 19 11/16 in</p>
	 <p><b>J - 8% (7 units/pallet)</b></p> <p>90 x 130 x 550 mm</p> <p>3 3/16 x 5 1/8 x 21 5/8 in</p>
	 <p><b>K - 8% (7 units/pallet)</b></p> <p>90 x 130 x 600 mm</p> <p>3 3/16 x 5 1/8 x 23 5/8 in</p>
	 <p><b>L - 18% (14 units/pallet)</b></p> <p>90 x 130 x 650 mm</p> <p>3 3/16 x 5 1/8 x 25 5/8 in</p>

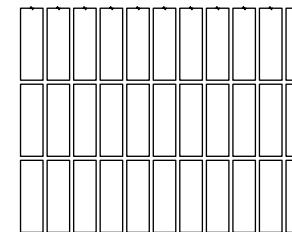
## Visconti

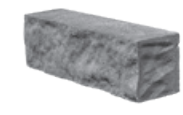
Bricks	Sold by full pallet
<p>CUBING</p> <p>9,58 m<sup>2</sup> / 103,15 ft<sup>2</sup> per pallet</p> <p>1,20 m<sup>2</sup> / 12,89 ft<sup>2</sup> per row</p> <p>27,55 units per m<sup>2</sup> / 2,56 units per ft<sup>2</sup></p> <p>1707 kg / 3763 lbs</p> <p>264 units</p> <p>8 row of 33 units</p>	
	 <p><b>Regular - 67% (176 units/pallet)</b></p> <p>90 x 100 x 320 mm</p> <p>3 3/16 x 3 13/16 x 12 5/8 in</p>
	 <p><b>Corner - 33% (88 units/pallet)</b></p> <p>90 x 100 x 320 x 315 mm</p> <p>3 3/16 x 3 13/16 x 12 3/8 x 12 5/8 in</p>

## COLOR

Due to the inherent nature of printed literature and current digital media, Techo-Bloc cannot guarantee specific colour matching to printed representations of its colour swatches. Therefore, colour samples shown are reproduced as precisely as possible but may vary from actual product colours.

Final colour selection should be made at your local dealer from stocked product. Techo-Bloc always recommends immediately verifying the product and colour upon reception to ensure that the delivered materials correspond to your order. If there are any discrepancies, contact your local dealer before continuing your project. Installation of the product constitutes your acceptance of the product as is.

For a natural appearance, each shade of colour is composed of a variety of darker & lighter tones. Natural aggregates such as granite are present within the recipe to allow for a range in tones, veining and textures from one stone to another. All Techo-Bloc bricks and stones feature through-and-through color which allows them to be cut on-site while preserving their appearance (except for Stonedge products).

## PROPER COLOR DISTRIBUTION AND LAYERING TECHNIQUES

Proper installation enhances the overall colour of masonry elements. To achieve beautiful results, units should be randomly picked from at least four pallets of the same lot number, and installed alternately when installing. This creates an attractive and subtle blending of colour. Techo-Bloc accepts no responsibility or liability whatsoever if installation does not follow these guidelines.

## EFFLORESCENCE

This warranty does not apply to efflorescence. Efflorescence is a natural occurring process in all concrete products which sometimes appears in the form of a white powdery film on the surface. Efflorescence is more perceivable in darker colours such as Onyx Black and Charcoal as there is a higher level of contrast than with other blended colours. It does not, in any way, compromise the functionality or the structural integrity of the product. Although efflorescence cannot be prevented, the rain will wash it off over time. Efflorescence can also be cleaned with a product compliant with Techo-Bloc's or the cleaning product's directives. Techo-Bloc accepts no responsibility or liability for this condition.

## CONSTRUCTION RESIDUE

By-products of cutting with a saw are residue-filled water and concrete dust. Residue-filled water or re-hydrated dust can cling to the surface and leave stains. It is recommended to wash and remove the water or concrete dust from the masonry's surface before it dries. Organic residues may also stain surfaces during construction. These contaminants should be removed immediately but do not affect the integrity of the product or your installation. Techo-Bloc accepts no responsibility or liability for these occurrences.



The Techo-Bloc warranty is applicable to all masonry products manufactured by Techo-Bloc. We are proud to certify that these products meet and/or surpass the requirements of the Canadian Standards Association (CSA A165.04) and the American Society for Testing Materials (ASTM-C55). These standards provide requirements for density, absorption, compressive strength, as well as, materials, facing, sampling/testing, and packaging.

Techo-Bloc guarantees the lasting structural integrity of its masonry products for a period of 50 years and warrants that its products are free from manufacturing defects.

This warranty is offered to the original purchaser of the product with proof of purchase. It applies to original installations only; once the masonry product is removed from its original installation, the Techo-Bloc warranty is no longer applicable.

In the case where building standards, regulations and Techo-Bloc's own guidelines were not adhered to during the product's installation process, Techo-Bloc cannot take responsibility for the product's deterioration resulting from poor installation.

Efflorescence is the result of a naturally occurring phenomenon in concrete materials, which appears on the surface in the form of a white powdery layer. Various efflorescence cleaning products are available on the market. Due to the organic nature of this process, Techo-Bloc cannot accept responsibility or liability for this natural occurrence. For additional information on efflorescence, please visit the technical publications section of <http://www.masonryinstitute.org>.

In the case of a warranty claim deemed legitimate through a product inspection, Techo-Bloc will honor its warranty by exchanging the Techo-Bloc material. Techo-Bloc's responsibility is limited solely to the product and is not responsible for any installation costs. It is the responsibility and upon the good faith of the installer to inspect the delivered material and to advise Techo-Bloc should there be any issues prior to installation of the materials. Once installed, Techo-Bloc cannot guarantee the color match of any replacement units.

This warranty does not apply to natural wear or any damage resulting from a natural disaster, product handling or from a deliberate and/or negligible act on the part of the purchaser, owner of the building, installer or any third party.

Should you require assistance, please contact the authorized Techo-Bloc retailer from which you purchased the product or Techo-Bloc's customer service department at 1.877.832.4625. We take pride in our high-quality products and in satisfying our customers.

### NOTE:

To give them their distinct appearance, the products in the Stonedge Collection are manufactured with a different process from our other product lines. Although they comply with the most recent industry standards both in Canada and in the United States, Techo-Bloc's warranty on the use of de-icing salts does not apply to Stonedge products.



## Landscape Catalog

Need inspiration for \_\_\_\_\_  
your backyard project?

Discover top design trends and the best  
landscaping products!

From patio stones to outdoor fire pits, browsing our catalog will surely inspire you while designing your outdoor space. Our catalog is centered around the design pillars that make Techo-Bloc products stand out from the rest. We focus on showing how to play with color, scale and texture to elevate your next landscaping renovation.

[techo-bloc.com/collection/catalogs](https://techo-bloc.com/collection/catalogs)



# Institutional, Commercial & Industrial

## Where design meets durability

With over 35 international patents, we aim to strike the perfect balance of natural hues and incredibly-authentic textures across a diverse range of scale. Discover the widest selection of commercial grade pavements engineered to bring your design to life, even in the harshest environments.

Visit [techo-bloc.com/specifier](https://techo-bloc.com/specifier)



# TECHO — BLOC

INSPIRING ARTSCAPES



Masonry Catalog