

# TECHO — BLOC

INSPIRING ARTSCAPES









# Inspiring Artscapes

You're not looking to blend in,  
but rather stand out from the crowd.  
We take that philosophy to the outdoors,  
reshaping the idea of what  
landscapes can look like.



**WE LIVE TO CREATE**



# Step Outside the Ordinary

Knowledge, passion, innovation and an eye for design – these are the qualities that brought Techo-Bloc to life and continue to drive its success. But even more important than these qualities are the people who embody them: Co-founders Charles Ciccarello and Nancy La Rocca.

When Charles and Nancy's paths crossed, they were undeniably a perfect match. Little did they know, their complicity would transcend the personal to create an unstoppable business partnership.

As the son of a landscaper, Charles was exposed to the industry from a young age and quickly became captivated by the craft. He would spend every summer learning and soaking in every part of it, but something always left him feeling uninspired: no matter how creative they would get, they were always limited by the materials, and the properties they worked so hard to transform were left looking ordinary. And so, at the age of 18, he sought to break the mold that was confining the industry.

Then entered Nancy. Daughter of a high-end residential developer and designer, she immediately saw the value in treating the outdoors as you would your indoor spaces. This meant creating pavement options with eye-catching colors, different shapes and sizes, and striking textures –

options that would break the mold of the cookie-cutter style brick everyone was installing. And so, armed with a passion for aesthetics, design-driven vision, and a great sense of operational organization, she would become the biggest supporter of her visionary husband, playing an essential role in the founding and growth of Techo-Bloc.

Her quest to create products that bring art into the outdoors, paired with Charles' determination to create products that would make installation challenges and engineering limitations obsolete, made them a force to be reckoned with. They haven't rested since.

Today, their success has allowed for Techo-Bloc's distribution network to grow to over 700 stores across the USA & Canada, and for their team to grow from five employees to over 800. But, that's not all. They have also inspired a community of contractors, architects and designers that all work towards a common goal: to create inspiring artscapes.

Together, Charles and Nancy continue to step outside the box to impress, to surpass industry standards and to push the envelope beyond existing options for outdoor spaces. Keeping true to their beginnings, every day they try to find new ways to carve new molds because they will never be comfortable fitting into anyone else's idea of good enough.







# Table of Contents



## look

- 10 Up & Coming Trends
- 20 A Look Back at 2021

## learn

- 30 The Design Pillars
- 34 Pairings
- 36 Mosaics
- 42 Permeable Solutions
- 46 Technologies
- 50 Planning Tools





## slabs

54	Aberdeen
56	Blu 60 mm Slate
58	Blu 60 mm Smooth
60	Borealis
62	Borealis Stepping Stone
63	Maya
64	Everest
66	Hexa 60 mm
67	Inca
68	Industria
69	Ocean Grande
70	Para
72	Travertina Raw
74	Blu 45 mm overlay system
75	Pacific overlay system

## pavers

78	Antika
79	Aquastorm
80	Blu 80 mm Slate
82	Blu 80 mm Smooth
84	Diamond
86	Hexa 100 mm
88	Eva
89	Hydra
90	Industria
92	Linea
93	Mika
94	Mista
95	Pure
96	Sleek
97	Squadra
98	Travertina Raw
99	Valet
100	Victorien
101	Westmount
102	Villagio



## walls

120	Fascia Iconic
121	Fascia Rosemont
122	Borealis
124	Brandon
126	Graphix
128	G-Force
129	Prescott
130	Mini-Creta Architectural
132	Raffinato
134	Röcka
136	Semma
137	Skyscraper
138	Travertina Raw

## caps

142	Compatibility Chart
144	Bali Travertina Raw
144	Bullnose
145	Bullnose Grande
145	Portofino
146	Architectural
146	Brandon
147	Graphix
147	Piedimonte
148	Raffinato
149	Travertina Raw
149	York



## outdoor features

106	Brandon Fire Pit
108	Prescott Fire Pit
109	Raffinato Fire Pit
110	Valencia Fire Pit
111	Manchester Foyer

## edges

114	Borealis
115	Avignon
115	Brandon
116	Pietra
116	Raffinato
117	Röcka

## legend

	Techo-Bloc Collection
	Stonedge Collection
	De-icing Salt Resistant
	Permeable

	HD <sup>2</sup>
	HD <sup>2</sup> Plus
	Klean-Bloc



## steps

152	Borealis
153	Maya
154	Raffinato
155	Röcka
156	York
157	Venetian

## resources

158	Color Coordinate
160	Warranty
162	Accessories
163	Commercial Products

For an authentic look, each color option is composed of a variety of darker & lighter tones. Natural ingredients are present within the recipe to allow for a range in tones, veining and textures from one stone to another. Color samples for reference only. Actual product colors may vary.

Midwestern USA encompasses these states: AR, CO, GA, IA, ID, IL, IN, KS, KY, MI, MN, MO, MS, ND, NE, OH, Western PA, SD, TN, WI & WV.

Eastern USA encompasses these states:  
CT, DE, MA, MD, ME, NC, NH, NJ, NY, Eastern PA, RI, SC, VA & VT.



# Look

Discover the hottest trends of the moment.

We present an overview of some of the most important trends for 2022, followed by a selection of projects carried out during 2021 to inspire creativity when designing outdoor spaces.

- 10 Up & Coming Trends
- 20 A Look Back at 2021









# Up & Coming Trends

## Trend # 1 Sustainable landscaping... naturally

**WATER HARVESTING** It's said that "April showers bring May flowers", but with a little preparation, you can put this free source of H<sub>2</sub>O to work any month of the year. Install a receptacle to collect rainwater, then use it to fill fountains, ponds, or other water features around your property. It's also an eco-conscious way to keep lawns and gardens hydrated.



Antika paver in Shale Grey and Villagio paver in Onyx Black



Aquastorm paver in Grey

**PERMEABILITY** When it rains, it pours. Permeable pavers are specially designed to help you keep storm water, snow and ice under control, while also keeping your eye on the environment. This attractive, durable and smart solution may also be eligible for tax incentives and other credits in certain municipalities — which makes it attractively cost-effective, too.





Industria 600 series slab in Greyed Nickel

*SUSTAINABLY  
STYLISH*

**XERISCAPING** Lush, blooming gardens can be gorgeous, but they also guzzle gallons of water. For a smart way to work with arid climates and reduce your consumption, give xeriscaping, or drought-resistant landscaping, a dry run. Opt for native plants that are big on style but low on irrigation and maintenance needs to enjoy a spectacular landscape that won't go thirsty.





Para slab in Greyed Nickel, Industria Triangle paver in Greyed Nickel, Shale Grey and Onyx Black, Westmount paver in Shale Grey and Onyx Black with Raffinato wall, cap and step in Greyed Nickel

## Trend # 2 All day, every day

**DAY TO NIGHT TRANSITION** Your backyard should be able to work the day and night shift. From an evening bar that doubles as a snack bar, a seating area that transforms into a fireside chat, or hidden lighting that makes your backyard come to life at night; the best backyards transition from day-to-night to keep the party going.





# ART DECO DESIGN

**OUTDOOR ENTERTAINING** Movie buffs rejoice! A glitzy patio sets the stage for movie nights under the stars. This Art Deco inspired pattern is the perfect backdrop for your family film festivals.





**MULTI-FUNCTION SPACE & CUSTOM FEATURES** Multifunction is the name of the game, with layouts cleverly designed to incorporate all that you love about being outdoors. From a covered patio housing an outdoor kitchen for the family chef, to a swinging bar to gather guests, enjoy the great outdoors at its best.

FOR YOUR  
LIFESTYLE



Blu Grande slab in Greyed Nickel and Borealis slab in Smoked Pine





Borealis wall in Hazelnut Brandy

## GOURMET GARDENS

If your gardening style is more functional than flowery, planting produce is a bountiful way to feed your garden-to-table appetite. It's a fun, interactive and satisfying way for the whole family to get their hands dirty, then enjoy the fruits (and vegetables, and herbs) of their labor come harvest time.

GARDEN  
TO TABLE



Graphix wall in Greyed Nickel and Onyx Black



## Trend # 3 The art of aesthetics

**ORGANIC, SOFT SHAPES AND TEXTURES** If the straight and narrow isn't always your style when it comes to the design of your outdoor space, don't be afraid to step out of line. Taking hints from interior design, use organic shapes and soft textures to add character and contrast, while incorporating curves to create a natural-feeling flow that connects you to your surroundings.



Blu Grande slab in Greyed Nickel and Bullnose Grande cap in Greyed Nickel





Industria Triangle Smooth and Granitex paver in Beige Cream

**LIGHTING** If you're enjoying your outdoor space so much that day turns to night, we've got a brilliant solution: just add light. To inject an element of surprise, arrange some lighting cleverly on a wall and watch it transform into a work of art by night. Strategically placed lighting is a dazzling way to amp up the atmosphere once the sun goes down.



Travertina Raw slab in Ivory and Rock Garden Brown

**ART ON THE WALLS** Design for the art of it: With a little creative flair, your entire outdoor space can become a larger-than-life masterpiece. At ground level, use slabs and pavers to create intricate patterns and interesting mosaics. Then keep the theme going vertically by dressing up walls with complementary artworks.





Borealis slab and step in Smoked Pine and Blu Grande slab in Shale Grey

## Trend # 4 Next-level cottage comforts

**HIGH-END STAYCATIONS** With both remote working and vacation rental interest on the rise, landscape design at cottages and country homes has taken a step in a stylish direction. Dwellers are gravitating toward inviting spaces decked out with creature comforts like fire pits with built-in seating, contemporary outdoor eating areas, and clever lighting solutions. Whether for work, play or as an income property, the return on investment is irresistible.



Blu Various sizes slab in Greyed Nickel and Brandon firepit in Chestnut Brown



# COTTAGE VIBES

**FINISHES THAT BLEND WITH NATURE** If the backdrop for your country home is nonstop nature, clever landscaping ideas can help your haven fit right in. Stone and wood look-alike products pave the way to natural-feeling layouts that celebrate the surrounding elements and enhance the homey atmosphere of your sweet retreat.



Borealis slab in Smoked Pine



Blu Grande slab in Greyed Nickel

**STEPS THAT LEAD TO THE WATER** Which way to the water? Take a step in the right direction with a walkway or stairway that mimics natural stone. It's an attractive and practical way to lead cottage-goers to the lake or river's edge.



# A Look Back at 2021

Discover standout projects that  
will inspire creative design for  
your landscape renovation.



Borealis slab, wall and step in Hazelnut Brandy  
with Raffinato cap in Onyx Black





GET IN TOUCH  
WITH TEXTURE

## From the ground up

📍 **NAPERVILLE, IL USA**

Stones don't have to stay on the ground. Think outside the blocks by stacking Borealis stones vertically to section off spaces, build up flower beds, form steps, and give a patio area a sense of seclusion. Stand the same stones on end to form the frame of a fire pit that fits seamlessly into the overall design.



# Larger than life

📍 RUMSON, NJ USA

Combine large stones with creative spacing and you've got a straight line to divine. Versatile slabs make a huge statement, whether laid out as stepping stones or standing in as a low-maintenance alternative to lawns and gardens.

*LUXURIOUSLY  
LOW-MAINTENANCE*







Industria 900 series paver in Greyed Nickel and Raffinato cap in Greyed Nickel



# Outdoor elegance, elevated

📍 POTOMAC FALLS, VA USA

Areas designed for different purposes harmonize perfectly, thanks to a consistent application of Graphix wall. An outdoor kitchen and raised eating area take the dining experience to the next level, while the lower lounge and fire pit are ideal for stepping things down a notch. When night falls, integrated lighting in the steps, walls and fire pit creates an enchanting ambiance.



Blu Grande slab in Shale Grey with Graphix wall in Onyx Black and Graphix cap in Greyed Nickel





Hexa slab in Beige Cream and Shale Grey with Blu 6x13 slab in Beige Cream and Shale Grey, Squadra paver in Onyx Black and Para in Beige Cream



## Boundaries, re-defined

📍 **BROSSARD, QC CANADA**

Design dynamo: Start by breaking the border rules. Create a whimsical transition between adjoining spaces by staggering six-sided Hexa stones into lush lawn. Framing large slabs with decorative banding in a complementary color adds extra definition to an elevated deck.





Para slab 500×500 and 500×250 with Raffinato wall, cap and step in Beige Cream





## Everlasting Escape

📍 CARMEL, IN USA

Lawn lovers rejoice: you can create a pathway to outdoor leisure without giving up your green. Precise placement in striking symmetric patterns means paving stones and natural elements can play nicely together, rather than compete for space.





# Learn

Design the right way with our tips to stand out.

Choosing the right products and knowing how to combine them to enhance a design, paired with taking advantage of the latest technologies and tools to achieve the best finish are key to succeeding and providing added value when designing outdoor spaces.

- 30 The Design Pillars
- 34 Pairings
- 36 Mosaics
- 42 Permeable Solutions
- 46 Technologies
- 50 Planning Tools









# The Designer Playground

Shapes and colors. Scales and proportions. Materials and finishes. This is where every element comes to play in a perfectly orchestrated game of style mastery.

## 01 Choose Your Favorite Color

We love naturals. Thoughtful planning of our color selection means that all your favorite shades show up in multiple collections, making it easy for you to mix, match and contrast to your heart's content. Refer to our color chart on p.158 to find which products are available in your favorite colors.



Color samples are for reference only and actual product colors may vary.



## 02 Which Texture Do You Prefer?

They may be concrete, but we prefer to call them *trompe l'œil*. These textures trick the eye with surface appearances that range from super smooth to ultra-detailed, and stay true even to the touch.

### AVAILABLE TEXTURES

HD<sup>2</sup>+ Smooth / HD<sup>2</sup> Smooth / Smooth  
 Klean-Bloc Slate / HD<sup>2</sup> Slate / Slate  
 Klean-Bloc Travertine / Brushed Travertine  
 Klean-Bloc Wood / Wood  
 HD<sup>2</sup>+ Natural Stone / Natural Stone  
 HD<sup>2</sup> Polished / Polished  
 HD<sup>2</sup> Granitex  
 Ocean Waves  
 Basalt  
 Split Face







### 03 Which Scale Suits Your Space?

Mind the scale you're working with. Larger stones are fit for grand spaces while smaller ones are ideal for banding, contouring and mosaics.



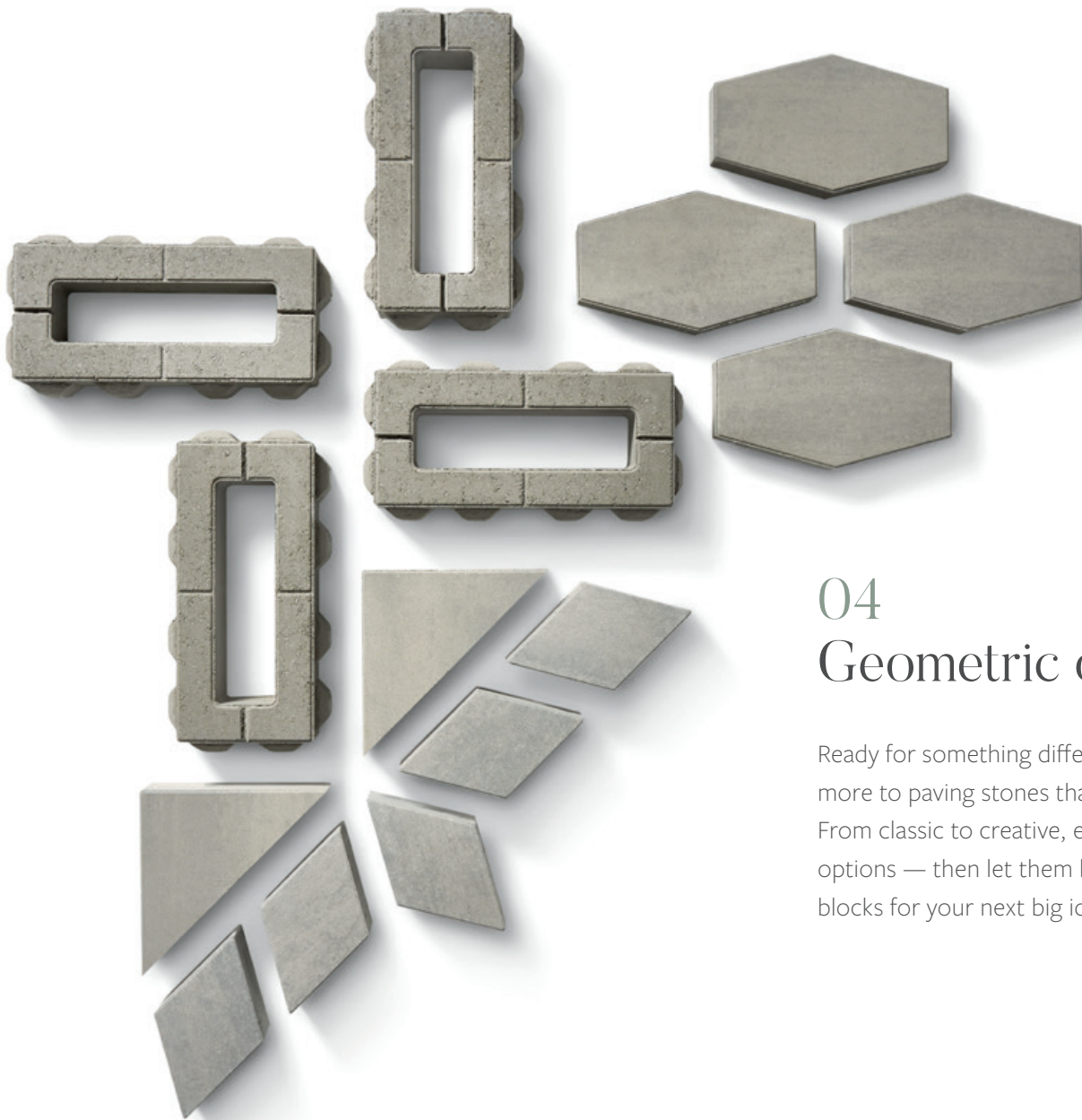

## 04 Geometric or Curvy?

Ready for something different? There's a lot more to paving stones than just right angles. From classic to creative, explore all the options — then let them be the building blocks for your next big idea.





# Perfect Pairings

From coordinated color schemes to flawless finishes, backyard blends are made easy with our cross category collections. Discover the perfect design pairing for your outdoor space that focuses on seamless surfaces from top to bottom.



## THE TEXTURED TOUCH

Win by playing the same game. From slabs to pavers to copings and beyond, discover the beauty of working within one consistent texture.

Travertina Raw slab, paver, wall & cap in Ivory





### TONE ON TONE

Same, but different. We color-match across our collections, making it easy to mix textures, shapes and sizes.

Graphix wall, Raffinato cap & Diamond paver in Greyed Nickel



### NATURE FINISHES FIRST

Different products, one-of-a-kind feeling. Keeping with a similar finish across collections creates an effortlessly natural or rustic-feeling cohesiveness.

Everest slab, Valet paver, Röcka wall & Piedimonte cap





# Mosaics: Mix & Match

From larger than life to small and subtle, to super smooth or ultra-detailed, mix and match to your heart's content. Be it a driveway, backyard or outdoor kitchen, play with scale, texture, shapes and a variety of colors to design an outdoor space that's as expressive as you.

The spectacular woven effect created by smaller, rough-hewn pavers amongst elegantly large slabs keeps the eye guessing and your guests swooning.

Blu Grande HD<sup>2</sup> Smooth slab in Greyed Nickel, Valet paver in Onyx Black and Squadra paver in Onyx Black







Texture is a brilliant way to add a subtle shakeup to your outdoor floor plan. Laying tone-on-tone but different-textured Diamond pavers in a seemingly random pattern looks at once casual and perfectly polished.

Diamond HD<sup>2</sup> Smooth & HD<sup>2</sup> Granitex in Beige Cream



A strong geometric pattern displays a slightly softer side when built from sophisticated shades of grey.

Industria 600×600 HD<sup>2</sup> Smooth in Greyed Nickel, Shale Grey & Onyx Black

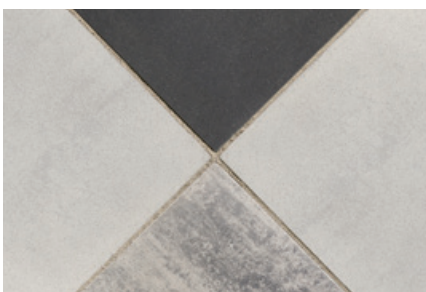



Herringbone paves the way.  
Wood-like slabs arranged at  
90-degree angles show off  
textural depth in the light of day.

Borealis 5 × 30 HD<sup>2</sup> in Smoked Pine



High definition dining space; linear  
stones are ‘woven’ together to form  
a carpetlike chevron pattern.

Blu Grande HD<sup>2</sup> Smooth in Beige Cream  
paired with Westmount HD<sup>2</sup>+ in Merlot

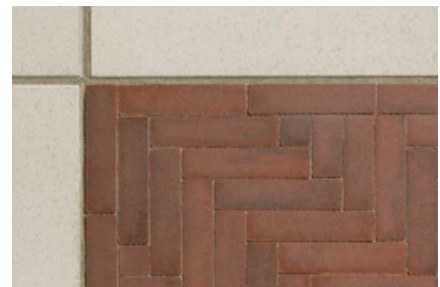





Creative angle: A seemingly spontaneous layout of two-tone stones turns a sunken seating area into the main draw.

Industria Triangle HD<sup>2</sup> Smooth in Chestnut Brown & Beige Cream





What makes this pattern so striking?  
We did the math and it's a perfect fit: the large stones are as wide as the small ones are long.

Para 500×750 HD<sup>2</sup> Smooth in Greyed Nickel  
paired with Para 250×500 HD<sup>2</sup> Smooth  
in Onyx Black



Putting a spin on the traditional Hexagon paver that was often used for historic homes and buildings, Hexa takes a classic look and elevates it for modern landscape designs.

Hexa slab in Beige Cream and Shale Grey







Make a no-holds-barred statement with slim and linear pavers that create gentle movement when set against large stones.

Industria 600×600 in Shale Grey paired with Westmount HD<sup>2+</sup> in Shale Grey & Onyx Black



Discover more with  
the Design Playground



SCAN THE QR CODE OR VISIT  
[WWW.TECHO-BLOC.COM/DESIGN](http://WWW.TECHO-BLOC.COM/DESIGN)







# Eco- conscious

## Permeable solutions

Urbanization has led to the covering up of naturally permeable vegetation such as forests and grasslands, replacing it with hard surfaces like buildings, roads, and parking lots. The opportunity for infiltration and evapotranspiration of rainfall has dramatically reduced and surface runoff has become the primary drainage mechanism. As water runs off urban surfaces it picks up sediment, road salts, metals, oils, pesticides and other harmful pollutants, which are being fed to our rivers and lakes. With climate change increasing the frequency of heavy rains and accelerated snowmelt causing additional stress on our environment, we are pressed to find sustainable ways to update outdoor spaces with groundwater infiltration in mind.

Designed to allow water to pass through the joints and seep into the ground rather than being channeled into storm drains, permeable pavements made their debut in Europe over 50 years ago. Permeable pavements are a good example of green infrastructure, as they aid in attaining pre-development hydrological conditions by increasing infiltration and evaporation and reducing runoff volumes and flow rates.<sup>1</sup>

*RAIN WATER FLOWS  
THROUGH THE LAYERS*

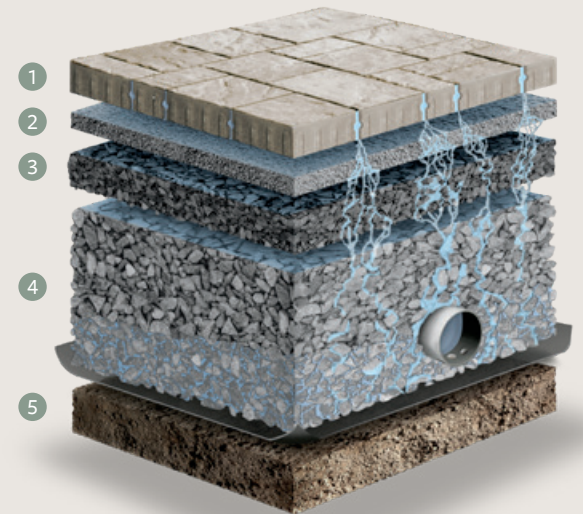

### 1. PERMEABLE PAVER

Designed with larger joint space to allow storm water to percolate through.

### 2. SMALL AGGREGATE (2.5-10 mm)

Filters out contaminants and debris from the rainwater.

### 3. MEDIUM AGGREGATE (5-28 mm)

Transition layer that further filters out pollutants.

### 4. LARGE AGGREGATE (40-80 mm)

Reservoir layer for rainwater harvesting and the evacuation of excess water through a drain pipe.

### 5. GEOTEXTILE

Filter fabric that separates large aggregate from the soil underneath.





Diamond paver in Greyed Nickel and Shale Grey

### GIVE NEW MEANING TO THE TERM “ENVIRONMENTALLY CONSCIOUS”

Techo-Bloc permeable pavers offer all the desirable features of traditional pavers, plus the added functionality of effective surface water management and improved groundwater infiltration.

Studies have shown an improvement of water quality by filtration through permeable pavement systems. They work well in removing suspended solids and particularly heavy metals from runoff, such as contaminants from vehicles, like heavy metals from brake dust, and petroleum distillates. They help capture and break down lead and copper, which show the highest pollutant concentrations in runoff associated with metal roofs, rainwater gutters and related pipes, since they often consist of zinc-coated sheets or copper.

In comparison to pavements made of asphalt, concentrations of zinc, copper and lead were significantly lower on permeable structures. Lead concentrations were in fact undetectable. As water runs through the permeable pavement’s joints and into the aggregate system below, particles usually accumulate in the stone-filled joints, base and geotextile fabrics holding them in place. Geotextiles usually separate micropollutants such as cadmium, zinc and copper from the underlying soil, therefore preventing groundwater from becoming contaminated.<sup>2</sup>



Grass or Turf



Clean Stone



Clean Stone



River Rock

Personalize your joint filling!  
Options range from clean stone,  
to river rock and even turf.



## EYE-CATCHING AND ECO-FRIENDLY

All in all, permeable interlocking concrete pavements are a solid way to treat your home to an elegant upgrade while keeping the grander environment in mind. And best of all, they come in a variety of designs and styles, allowing you to express your creativity and complement the aesthetics of your home. You can even amp up your design by personalizing your joint filling! Options range from clean stone to river rock and even turf. Stress less about flooding, puddling, ice accumulation and more without having to compromise on style. Bonus: Certain municipalities offer incentives such as tax credits and subsidies for the implementation of a rainwater management system, permeable pavement included.

<sup>1</sup> “Urban Runoff and Green Infrastructure - Step.” Sustainable Technologies Evaluation Program (STEP), <https://sustainabletechnologies.ca/home/urban-runoff-green-infrastructure/>.

<sup>2</sup> Kale, Saurabh Y.. “Permeable Pavement a step towards Sustainable Urban Drainage System.” Amit P. Halwele, Kartik Rathod, Mayur A. Jirapure, Vol. 4, Special Issue 3, January 2017, Yavatmal, India.



Blu Grande slab in Shale Grey



Bali Travertina Raw cap and slab in Ivory



If you see the permeable icon, some or all of the products in that collection are permeable.

### PERMEABLE BY DESIGN

- 79 Aquastorm
- 89 Hydra
- 95 Pure

### EXCELLENT PERMEABLE CAPABILITIES

- |                 |                   |
|-----------------|-------------------|
| 78 Antika       | 98 Travertina Raw |
| 80 Blu 80 mm    | 99 Valet          |
| 93 Mika         | 102 Villaggio     |
| 94 Mista Random |                   |

Visit [techo-bloc.com/permeable](https://techo-bloc.com/permeable) to learn more about how you can turn your landscape into an environmentally-friendly design.







# Exclusive Technologies



## NATURAL LOOK. UNPARALLELED DURABILITY.

At Techo-Bloc, we believe that no one should have to compromise between style and durability when choosing their landscaping products. That is why we work tirelessly to develop the best pavers and slabs to revive your outdoor spaces and ensure that they stand up to the test of time even in the harshest of climates.



DURABILITY

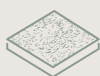

ULTRA-DETAILED  
TEXTURE



VIBRANT  
COLOR



STAIN  
RESISTANCE



REDUCED  
ABSORPTION RATE



SUPERIOR  
STRENGTH



DE-ICING SALT  
RESISTANT



•

•

•

•

•



•

•

•

•

•\*



•

•

•

•

•

•

•

\*Excluding Inca slab.

Look for these icons in this catalog:   





## Factory-applied protection for stain resistance.

### WORRY LESS. RELAX MORE.

Developed to seal in the beauty of wetcast products, Klean-Bloc technology creates an advanced protective barrier against everyday wear and tear. Enjoy the beauty and character of natural materials like travertine and wood grain, without the worry of maintenance.



-  DURABILITY
-  ULTRA-DETAILED TEXTURE
-  VIBRANT COLOR
-  STAIN RESISTANCE
-  REDUCED ABSORPTION RATE

### PRODUCTS WITH KLEAN-BLOC

54	Aberdeen slab	120	Iconic & Rosemont walls
60	Borealis slab	144	Bali Travertina Raw cap
72	Travertina Raw slab	147	Piedimonte cap
93	Mika paver	149	Travertina Raw cap
98	Travertina Raw paver	149	York cap



# A smart choice for a high-end finish.



## A NEW ERA OF CONCRETE

HD<sup>2</sup> is always ready for a close-up. Boasting higher particles per square inch, this drycast technology leads to a tighter surface for the most flawless of finishes.



-   
**DURABILITY**
-   
**ULTRA-DETAILED TEXTURE**
-   
**VIBRANT COLOR**
-   
**SUPERIOR STRENGTH**
-   
**DE-ICING SALT RESISTANT\***

\*Excluding Inca

## PRODUCTS WITH HD<sup>2</sup>

- |    |                   |    |                 |
|----|-------------------|----|-----------------|
| 56 | Blu 60 mm slab    | 80 | Blu 80 mm paver |
| 67 | Inca slab         | 84 | Diamond paver   |
| 68 | Industria slab    | 90 | Industria paver |
| 69 | Ocean Grande slab | 96 | Sleek paver     |
| 70 | Para slab         |    |                 |

# Taking your slabs and pavers to the next level.



## FACTORY SEAL FOR EXTRA-PROTECTION

Taking our already cutting-edge technology to the next level, HD<sup>2+</sup> has the added benefit of a factory seal for added stain resistance, elevated color boost and a reduced absorption rate.

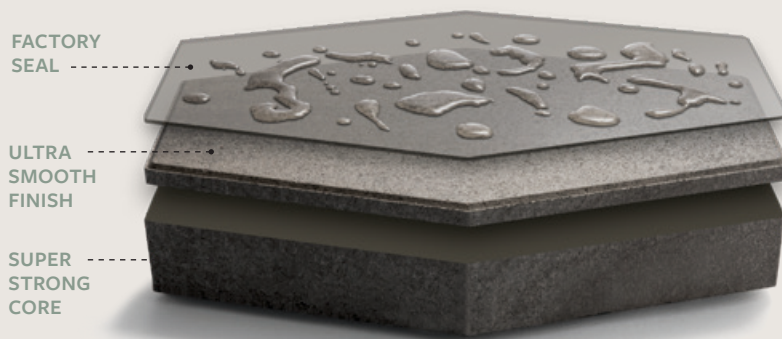

-   
**DURABILITY**
-   
**ULTRA-DETAILED TEXTURE**
-   
**VIBRANT COLOR**
-   
**STAIN RESISTANCE**
-   
**REDUCED ABSORPTION RATE**
-   
**SUPERIOR STRENGTH**
-   
**DE-ICING SALT RESISTANT**

## PRODUCTS WITH HD<sup>2+</sup>

- 64 Everest slab
- 66 Hexa slab
- 87 Hexa paver
- 101 Westmount paver



# Planning Tools



## THE PATH TO A BETTER LANDSCAPE

We've curated a collection of resources to get you from point A to point Z of your dream landscape.

EVERYTHING YOU  
NEED TO KNOW



1

### GET INSPIRED

From pool to patio, we've curated the best design ideas and trends in our online Lookbook!

2

### GET THE BACKYARD PLANNING GUIDE

This guide breaks down the steps to a well-planned and successful landscape renovation with tips on how to create your wishlist, budget breakdown and more!



3

### CHOOSE YOUR PRODUCTS

Find a Techo-Bloc dealer in your area and discover the products that will bring your vision to life.

4

### FIND THE RIGHT TECHO-PRO

Have our team help you select the right landscaping contractor for your project!

5

### PAVE NOW, PAY LATER FINANCING PROGRAM

Get the outdoor space of your dreams today by accessing this exciting program.



SCAN THE QR CODE OR VISIT  
[WWW.TECHO-BLOC.COM/TOOLS](http://WWW.TECHO-BLOC.COM/TOOLS)



# Slabs

## Make a big statement.

The appeal of home-based entertaining expands with the sizeable style of statement-making slabs. With nature-inspired colors and textures such as travertine, wood, sand and stone, our large-format slabs are uniquely designed to minimize seams and maximize compliments. Perfect for your walkway, patio, pool deck and any other vehicle-free area around your property.

- 54 Aberdeen
- 56 Blu 60 mm Slate
- 58 Blu 60 mm Smooth
- 60 Borealis
- 62 Borealis Stepping Stone
- 63 Maya Stepping Stone
- 64 Everest
- 66 Hexa 60 mm
- 67 Inca
- 68 Industria
- 69 Ocean Grande
- 70 Para
- 72 Travertina Raw
- 74 Blu 45 mm overlay system
- 75 Pacific overlay system









Slab

# Aberdeen



Rock Garden  
Brown



Azzurro

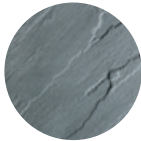

  
Factory-applied  
protection for  
stain resistance.

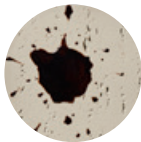

Rock Garden Brown

20 x 10 / 20 x 20  
Height: 2 1/4 in 57 mm

20 x 10  
508 x 254

20 x 20  
508 x 508

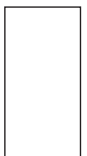

30 x 10  
Height: 2 1/4 in 57 mm

30 x 10  
762 x 254



30 x 20  
Height: 2 1/4 in 57 mm

30 x 20  
762 x 508



30 x 30  
Height: 2 1/4 in 57 mm



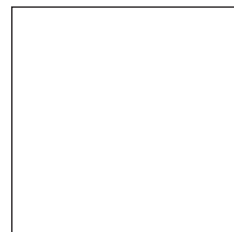











30 x 30  
762 x 762









	HD <sup>2</sup> Slate*	Slate
Chocolate Brown only available in 6 x 13		
Chestnut Brown		
Sandlewood** not available in 6 x 13		
Champlain Grey		
Shale Grey		
Onyx Black only available in 6 x 13		
		











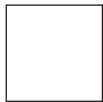

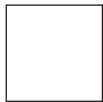
High definition finish with high density for extra durability.

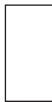
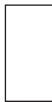
\*Only available in USA.

\*\*Sandlewood HD<sup>2</sup> only available in Eastern USA.  
See page 7 for list of Eastern States

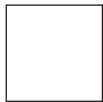

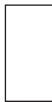
Grande - Champlain Grey - Slate

<p>Ⓢ Various sizes</p> <p>Height: 2 3/8 in 60 mm</p> <table border="0"> <tr> <td>13 x 6 1/2 330 x 165</td> <td>13 x 13 330 x 330</td> <td>13 x 19 1/2 330 x 495</td> </tr> <tr> <td></td> <td></td> <td></td> </tr> </table>	13 x 6 1/2 330 x 165	13 x 13 330 x 330	13 x 19 1/2 330 x 495				<p>Ⓢ 6 x 13</p> <p>Height: 2 3/8 in 60 mm</p> <table border="0"> <tr> <td>13 x 6 1/2 330 x 165</td> </tr> <tr> <td></td> </tr> </table>	13 x 6 1/2 330 x 165		<p>Grande</p> <p>Height: 2 3/8 in 60 mm</p> <table border="0"> <tr> <td>19 1/2 x 32 1/2 495 x 825</td> </tr> <tr> <td></td> </tr> </table>	19 1/2 x 32 1/2 495 x 825	
13 x 6 1/2 330 x 165	13 x 13 330 x 330	13 x 19 1/2 330 x 495										
												
13 x 6 1/2 330 x 165												
												
19 1/2 x 32 1/2 495 x 825												
												





# Blu 60 mm

Slate Collection





Slab

# Blu 60 mm

















Modern Collection







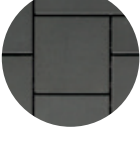

Various sizes - Greyed Nickel - Smooth

Polished* Not available in 6 x 13	HD <sup>2</sup> Smooth	Smooth	
			Chocolate Brown only available in 6 x 13
			Chestnut Brown
			Champlain Grey
			Beige Cream
			Greyed Nickel
			Shale Grey
			Onyx Black HD <sup>2</sup> Smooth not available in Grande
	<b>HD<sup>2</sup></b> High definition finish with high density for extra durability.		

④ Various sizes —————

\*\*Height: 2 3/8 in 60 mm

13 x 6 1/2 330 x 165	13 x 13 330 x 330	13 x 19 1/2 330 x 495
		

④ 6 x 13 —————

Height: 2 3/8 in 60 mm

13 x 6 1/2 330 x 165

Grande —————

\*\*Height: 2 3/8 in 60 mm

19 1/2 x 32 1/2 495 x 825

\*\*Polished is 2 5/16 in height.

\*Polished is made-to-order, minimum order of 500 sq. ft. Deposit required.







# Borealis



Smoked Pine



Smoked Pine

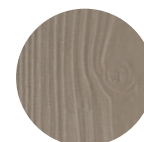

Hazelnut Brandy

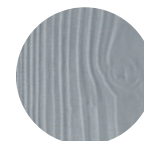

Riviera

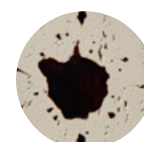

**KLE**  
Factory-applied  
protection for  
stain resistance.



5 × 30 —————  
Height: 2 ¼ in 57 mm

5 × 30  
127 × 762



10 × 30 —————  
Height: 2 ¼ in 57 mm

10 × 30  
254 × 762





# Borealis

## Stepping Stones



Hazelnut Brandy



Hazelnut Brandy



Stepping Stones

Height: 2 1/4 in 57 mm

24 x 24  
610 x 610

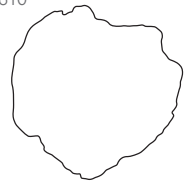



# Maya



4 Various Shapes

Height: 2 1/4 in 57 mm

23 x 31  
584 x 788

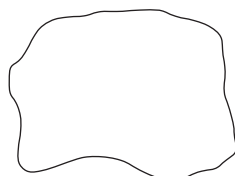







# Everest

T  **HD<sup>2</sup>+**



Greyed Nickel



Merlot



Chestnut Brown



Greyed Nickel



Shale Grey



**HD<sup>2</sup>+**  
High definition finish and extra-durability with factory seal for extra-protection.



250 x 250 ———  
Height: 2 3/8 in 60 mm

9 13/16 x 9 13/16  
250 x 250



250 x 500 ———  
Height: 2 3/8 in 60 mm

9 13/16 x 19 11/16  
250 x 500



500 x 500 ———  
Height: 2 3/8 in 60 mm

19 11/16 x 19 11/16  
500 x 500





# Hexa 60 mm

T  **HD<sup>2</sup>+**



Chestnut Brown

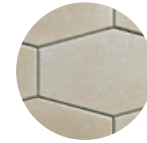

Beige Cream



Greyed Nickel

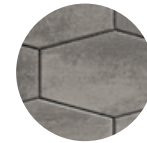

Shale Grey

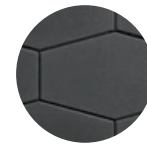

Onyx Black



**HD<sup>2</sup>+**  
High definition finish and  
extra-durability with factory seal  
for extra-protection.

Height: 2 <sup>3</sup>/<sub>8</sub> in 60 mm

9 × 15 <sup>3</sup>/<sub>16</sub>  
228 × 385

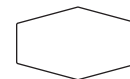



# Inca



Victoria

Various sizes

Height: 2 in 51 mm

15 x 7 1/2  
381 x 191

15 x 15  
381 x 381

15 x 22 1/2  
381 x 572



Victoria



Riviera





# Industria



HD² Polished    HD² Smooth    HD² Granitex



Chestnut Brown



Beige Cream

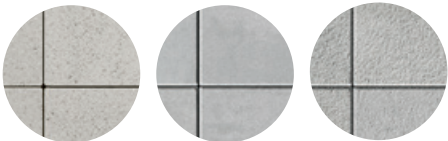

Greyed Nickel



Shale Grey



Onyx Black



**HD²**

High definition finish with high density for extra durability.



Greyed Nickel, Shale Grey & Onyx Black



600 Slab Series\*

\*\*Height: 2 3/8 in 60 mm

23 5/8 x 23 5/8  
600 x 600

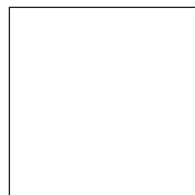

\*HD² Polished and HD² Granitex are made-to-order, minimum order of 500 sq. ft. Deposit required.

\*\*HD² Polished is 2 3/16 in - 58 mm in height



# Ocean Grande



Beige Cream



Greyed Nickel



**HD²**

High definition finish with high density for extra durability.



Height: 2 3/8 in 60 mm

19 1/2 x 32 1/2  
495 x 825



Beige Cream



Slab

# Para



Beige Cream



Greyed Nickel



Onyx Black



**HD<sup>2</sup>**

High definition finish with high density for extra durability.

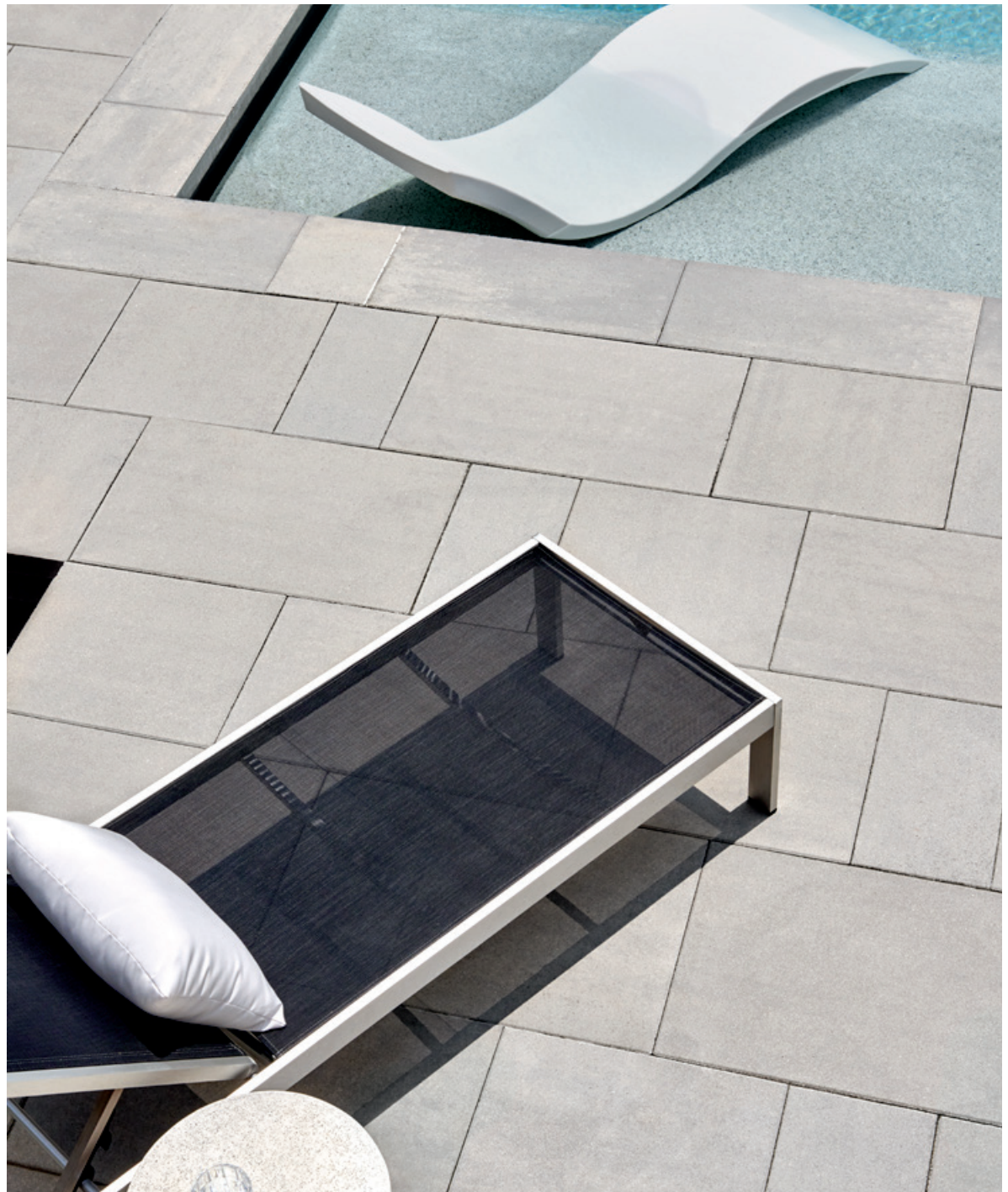

Greyed Nickel

500 x 250  
Height: 2 3/8 in 60 mm

19 11/16 x 9 13/16  
500 x 250



500 x 500  
Height: 2 3/8 in 60 mm

19 11/16 x 19 11/16  
500 x 500

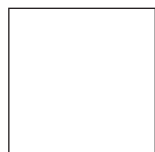

500 x 750  
Height: 2 3/8 in 60 mm

19 11/16 x 29 1/2  
500 x 750







Greyed Nickel & Onyx Black





Rock Garden  
Brown

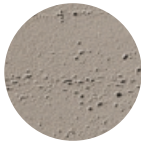

Ivory



Riviera

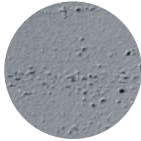

 Factory-applied  
protection for  
stain resistance.

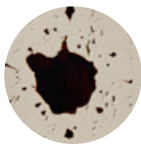

Ivory

20 x 10 / 20 x 20 —————  
Height: 2 ¼ in 57 mm

20 x 10  
508 x 254

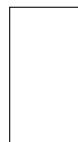

20 x 20  
508 x 508



20 x 30 —————  
Height: 2 ¼ in 57 mm

20 x 30  
508 x 762



30 x 30 —————  
Height: 2 ¼ in 57 mm

30 x 30  
762 x 762

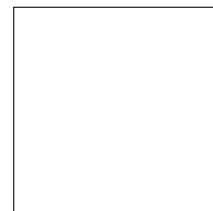



# Travertina Raw





# Blu 45 mm

Flooring overlay system

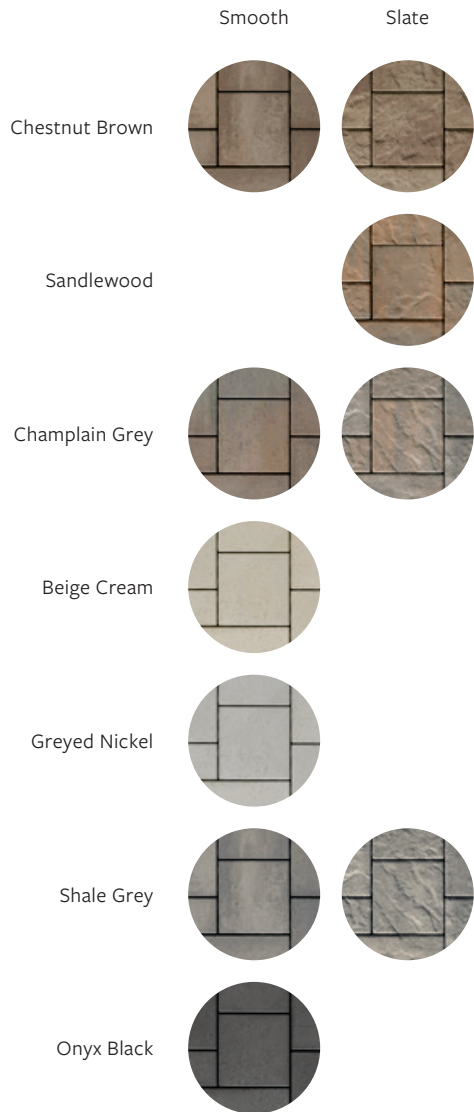
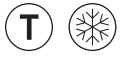

Greyed Nickel



Various sizes  
Height: 1 3/4 in 45 mm

13 × 6 1/2 330 × 165	13 × 13 330 × 330	13 × 19 1/2 330 × 495
-------------------------	----------------------	--------------------------







# Pacific

Cap & flooring overlay system

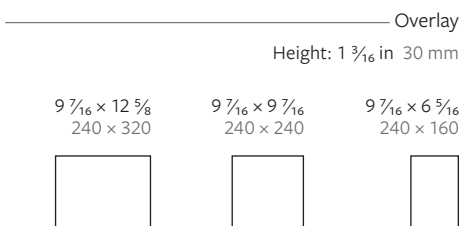
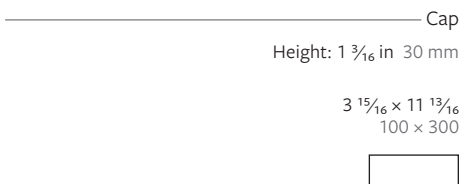

Champlain Grey



# Pavers

## Style in overdrive.

Our inspiring collection of interlocking paving stones makes it a snap to get creative: the vast selection of shapes, sizes, textures and colors is crafted to pair perfectly with our slab collections as well as your home. But these stones are built on more than just good looks — they're colorfast, salt-resistant and some permeable, perfect for going the distance on driveways, walkways and beyond.

- 78 Antika
- 79 Aquastorm
- 80 Blu 80 mm Slate
- 82 Blu 80 mm Smooth
- 84 Diamond
- 86 Hexa 100 mm
- 88 Eva
- 89 Hydra
- 90 Industria
- 92 Linea
- 93 Mika
- 94 Mista
- 95 Pure
- 96 Sleek
- 97 Squadra
- 98 Travertina Raw
- 99 Valet
- 100 Victorien
- 101 Westmount
- 102 Villagio









# Antika

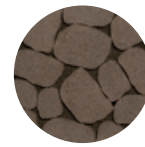

Chocolate Brown



Chestnut Brown



Sandlewood



Shale Grey

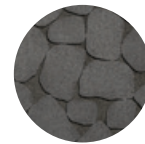

Onyx Black

Various sizes \_\_\_\_\_

Height: 2 3/8 in 60 mm





# Aquastorm



Grey

Height: 3 1/16 in 100 mm

10 1/16 x 20 1/16  
255 x 510

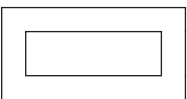

Grey  
with stone



Grey  
with grass





Paver

# Blu 80 mm

Slate Collection







6 x 13 Onyx Black - Slate paired with Various Shale Grey Slate

Slate	HD <sup>2</sup> Slate*	
		Chocolate Brown only available in 6 x 13
		Chestnut Brown
		Sandlewood** not available in 6 x 13
		Champlain Grey
		Shale Grey
		Onyx Black only available in 6 x 13
	<b>HD<sup>2</sup></b> High definition finish with high density for extra durability.	

\*Only available in USA.  
 \*\*Sandlewood HD<sup>2</sup> only available in Eastern USA.  
 See page 7 for list of Eastern States

Various sizes \_\_\_\_\_  
 Height: 3 1/8 in 80 mm

13 x 6 1/2  
 330 x 165

13 x 13  
 330 x 330

















13 x 19 1/2  
 330 x 495

6 x 13 \_\_\_\_\_  
 Height: 3 1/8 in 80 mm

13 x 6 1/2  
 330 x 165



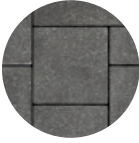
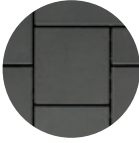

Polished* Not available in 6 x 13	HD <sup>2</sup> Smooth	Smooth	
			Chocolate Brown only available in 6 x 13
			Chestnut Brown
			Champlain Grey
			Beige Cream
			Greyed Nickel
			Shale Grey
			Onyx Black
	<b>HD<sup>2</sup></b> High definition finish with high density for extra durability.		



Various sizes - Greyed Nickel & 6 x 13 - Onyx Black

Various sizes \_\_\_\_\_

\*\*Height: 3 1/8 in 80 mm

13 x 6 1/2  
330 x 165



13 x 13  
330 x 330



13 x 19 1/2  
330 x 495



6 x 13 \_\_\_\_\_

Height: 3 1/8 in 80 mm

13 x 6 1/2  
330 x 165



\*Polished is made-to-order, minimum order of 500 sq. ft. Deposit required.

\*\*Polished is 3 1/16 in - 78 mm in height



# Blu 80 mm

Modern Collection



Various sizes - Shale Grey



# Diamond







Beige Cream in HD<sup>2</sup> Smooth & HD<sup>2</sup> Granitex

HD <sup>2</sup> Smooth	HD <sup>2</sup> Granitex*	
		Chestnut Brown
		Beige Cream
		Greyed Nickel
		Shale Grey
		Onyx Black
		High definition finish with high density for extra durability.

Height: 3 15/16 in 100 mm

12 5/16 x 7 1/8  
313 x 181



\*HD<sup>2</sup> Granitex is made-to-order, minimum order of 500 sq. ft. Deposit required.







# Hexa 100 mm

T ❄️ HD<sup>2</sup>+



Chestnut Brown & Beige Cream

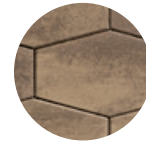

Chestnut Brown

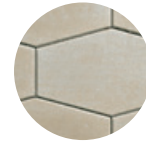

Beige Cream



Greyed Nickel

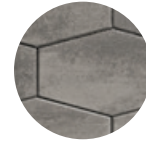

Shale Grey

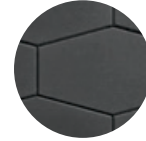

Onyx Black



**HD<sup>2</sup>+**  
High definition finish and extra-durability with factory seal for extra-protection.



Height: 3 1/16 in 100 mm

9 x 15 3/16  
228 x 385

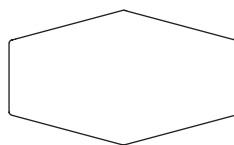

All colors are made-to-order, minimum order of 2,000 sq. ft. Deposit required.



# Eva



Chestnut Brown



Sandlewood



Champlain Grey



Shale Grey

Various sizes \_\_\_\_\_

Height: 2 3/8 in 60 mm

8 3/4 x 13 3/16  
223 x 335

8 3/4 x 8 3/4  
223 x 223

8 3/4 x 4 3/8  
223 x 112





# Hydra



Grey



Chestnut Brown



Grey



Shale Grey

Height: 3 1/16 in 100 mm

7 7/8 x 11 13/16  
200 x 300





# Industria







300 series - Triangle in Chestnut Brown & Beige Cream

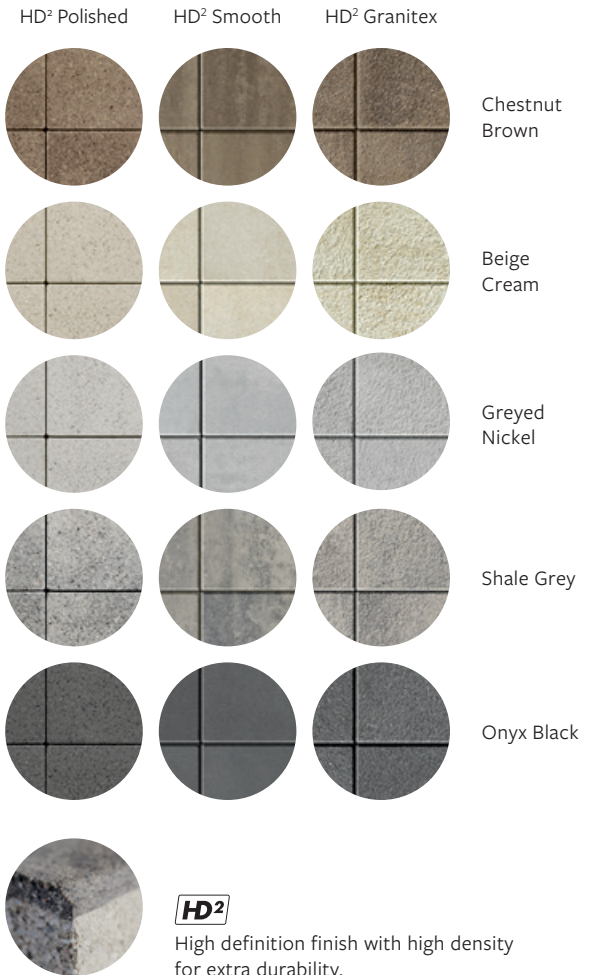

300 Series\*

Height: 3 1/16 in 100 mm\*\*

11 13/16 x 3 15/16  
300 x 100



11 13/16 x 5 7/8  
300 x 150



11 13/16 x 11 13/16  
300 x 300



Triangle  
11 13/16 x 11 13/16  
300 x 300



900 Series\*

Height: 3 1/16 in 100 mm\*\*

35 7/16 x 11 13/16  
900 x 300



35 7/16 x 23 5/8  
900 x 600



35 7/16 x 35 7/16  
900 x 900

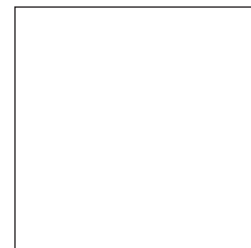

\*300 and 900 Series: HD² Smooth are in stock with shorter lead times. HD² Polished and HD² Granitex are made-to-order, minimum order of 500 sq. ft. Deposit required.

\*\*HD² Polished is 3 7/8 in - 98 mm in height

All other paver sizes are made-to-order, minimum order of 2,000 sq. ft. Deposit required.

All sizes are sold separately. Please refer to our website for all other available paver sizes.



# Linea

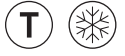

Chestnut Brown



Champlain Grey



Shale Grey



Onyx Black



Small Rectangle - Shale Grey paired with Villagio paver



### Small Rectangle

Height: 3 15/16 in 100 mm

3 15/16 x 8 7/8  
100 x 225



3 15/16 x 12 13/16  
100 x 325



3 15/16 x 16 3/4  
100 x 425



### Large Rectangle

Height: 3 15/16 in 100 mm

5 7/8 x 8 7/8  
150 x 225



5 7/8 x 12 13/16  
150 x 325



5 7/8 x 16 3/4  
150 x 425





# Mika



Rock Garden Brown



Onyx Black



 Factory-applied protection for stain resistance.

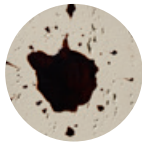

Height: 2 3/4 in 70 mm

4 7/16 x 11  
112 x 279



Rock Garden Brown



# Mista



Chestnut Brown



Sandlewood



Champlain Grey

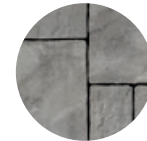

Shale Grey

④ Mista Random Permeable \_\_\_\_\_

Height: 2 5/16 in 65 mm

7 7/8 x 3 15/16  
200 x 100

7 7/8 x 7 7/8  
200 x 200

7 7/8 x 11 13/16  
200 x 300





# Pure

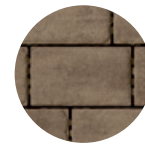

Chestnut Brown



Sandlewood



Champlain Grey

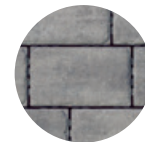

Shale Grey

Champlain Grey

Various sizes

Height: 3 1/8 in 80 mm

9 x 9 229 x 229	9 x 12 229 x 305	9 x 15 229 x 381
--------------------	---------------------	---------------------





# Sleek



Chestnut Brown

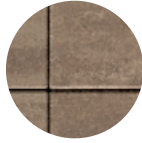

Champlain Grey

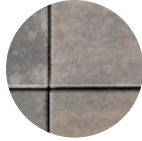

Beige Cream



Greyed Nickel

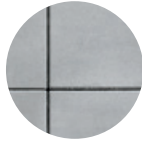

Shale Grey

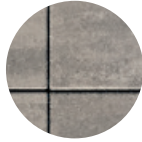

Onyx Black



**HD²**

High definition finish with high density for extra durability.



Greyed Nickel



Height: 3 <sup>7</sup>/<sub>16</sub> in 90 mm

15 <sup>7</sup>/<sub>8</sub> × 31 <sup>15</sup>/<sub>16</sub>  
404 × 811

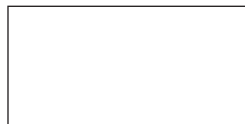



# Squadra

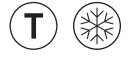

Merlot

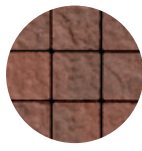

Chestnut Brown



Shale Grey



Onyx Black

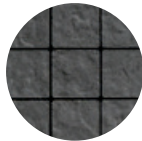

Height: 2 3/8 in 60 mm

3 1/4 x 3 1/4  
83 x 83



Onyx Black & Shale Grey



# Travertina Raw

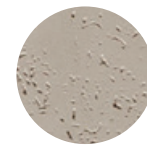

Rock Garden Brown

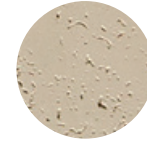

Ivory

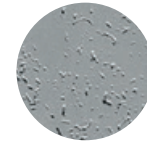

Riviera

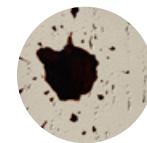

**KLE**  
Factory-applied protection  
for stain resistance.

Height: 2 3/4 in 70 mm

4 7/16 x 11  
112 x 279





# Valet



Shale Grey & Onyx Black

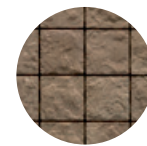

Chestnut Brown

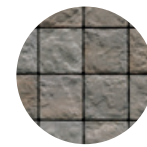

Champlain Grey

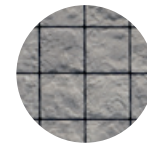

Shale Grey

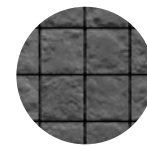

Onyx Black

Height: 2 3/8 in 60 mm

6 1/2 x 6 1/2  
165 x 165





# Victorien

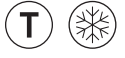

Chocolate Brown

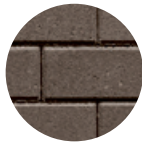

Shale Grey



Onyx Black

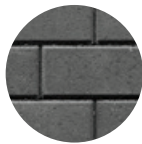

Onyx Black



Height: 2  $\frac{3}{8}$  in 60 mm

4  $\frac{1}{4}$  x 8  $\frac{1}{2}$   
108 x 216





# Westmount

T ❄️ HD<sup>2</sup>+



Merlot



Chestnut Brown



Shale Grey



Onyx Black



**HD<sup>2</sup>+**

High definition finish and extra-durability with factory seal for extra-protection.



Height: 3 1/8 in 80 mm

2 3/8 x 9 7/16  
60 x 240

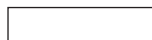

Shale Grey







# Villagio



Shale Grey & Onyx Black



Merlot



Chocolate Brown



Chestnut Brown



Sandalwood



Champlain Grey



Shale Grey



Onyx Black



Various sizes

Height: 2 3/8 in 60 mm

5 1/8 x 5 1/8  
130 x 130

5 1/8 x 6 5/16  
130 x 160

5 1/8 x 7 5/16  
130 x 185

5 1/8 x 8 7/16  
130 x 215





# Outdoor Features

## A spark of inspiration.

When you're entertaining outdoors, create unique spaces that will make your guests want to linger longer. Fire pits, fireplaces, pizza ovens and grill islands act as natural gathering places and become instant conversation starters. Whether you're seeking clean and contemporary lines or rustic earthy inspiration, outdoor entertainment never looked so good.

- 106 Brandon Firepit
- 108 Prescott Firepit
- 109 Raffinato Firepit
- 110 Valencia Firepitt
- 111 Manchester Foyer

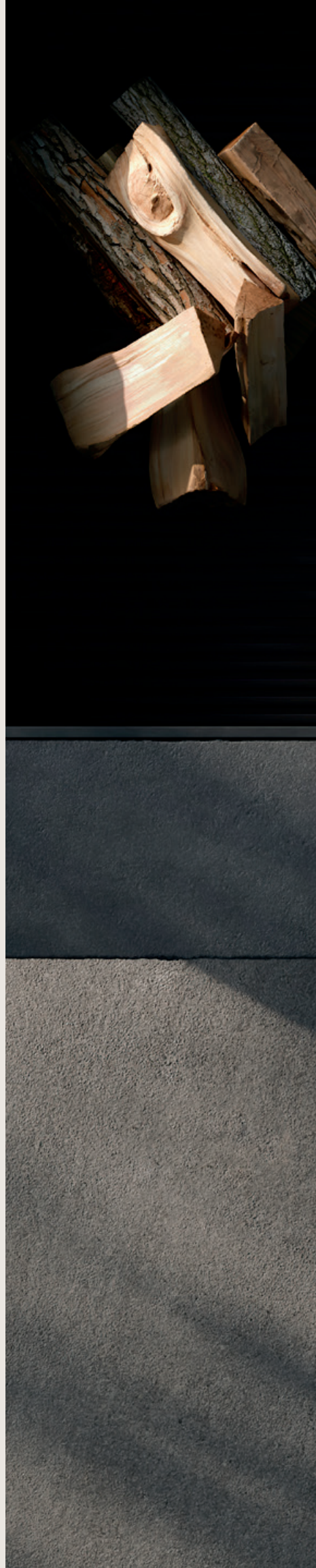







# Brandon

## Fire pit



Chestnut Brown

### Chestnut Brown

Fire pit  
Chestnut  
Brown



Cap  
Chestnut  
Brown



SQUARE	Height	Width	Length
in	19 1/16	53 1/2	53 1/2
mm	507	1 359	1 359
RECTANGLE	Height	Width	Length
in	19 1/16	44 1/2	57 3/4
mm	507	1 130	1 467

### Shale Grey

Fire pit  
Shale Grey



Cap  
Shale Grey



Available in wood, natural gas & liquid propane burning options. Visit [techo-bloc.com/warmingtrends](http://techo-bloc.com/warmingtrends) to discover more.

Raffinato 14" x 28" caps included. Metal fire pit insert sold separately. The installation of a sleeve or accessory kit will prevent damages to your firepit.





Shale Grey



# Prescott

## Fire pit



### Rock Garden Brown



Fire pit  
Rock Garden Brown



Cap  
Rock Garden Brown

### Riviera



Fire pit  
Riviera

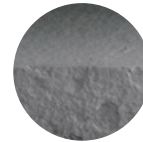

Cap  
Riviera

	Height	Width	Length
in	18	51 ¾	51 ¾
mm	457	1 314	1 314

Available in wood, natural gas & liquid propane burning options. Visit [techo-bloc.com/warmingtrends](http://techo-bloc.com/warmingtrends) to discover more.

Piedmonte caps included. Metal fire pit insert sold separately. The installation of a sleeve or accessory kit will prevent damages to your firepit.



# Raffinato

## Fire pit



Greyed Nickel & Onyx Black

### Beige Cream



Fire pit  
Beige Cream /  
Greyed Nickel

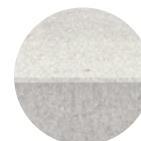

Cap  
Greyed Nickel

### Greyed Nickel



Fire pit  
Greyed Nickel /  
Onyx Black

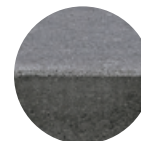

Cap  
Onyx Black

	Overall Height	Width	Length
in	21 ¼	41 ½	55 ⅞
mm	540	1 054	1 419

Available in wood, natural gas & liquid propane burning options. Visit [techo-bloc.com/warmingtrends](http://techo-bloc.com/warmingtrends) to discover more.

Raffinato 12" x 24" caps included. Metal fire pit insert sold separately. The installation of a sleeve or accessory kit will prevent damages to your firepit.



# Valencia

## Fire pit

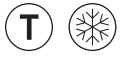

Chestnut Brown



Sandlewood



Champlain Grey



Shale Grey

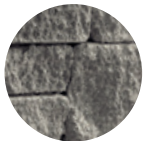

Chestnut Brown paired with Antika paver & Blu Slate slab

Insert sold separately

diameter: 29 1/8" 740 mm



	Height	Exterior Diameter	Interior Diameter
in	14 3/4	48 15/16	29 1/8
mm	375	1 243	740

Available in wood, natural gas & liquid propane burning options. Visit [techo-bloc.com/warmingtrends](http://techo-bloc.com/warmingtrends) to discover more.

The installation of a sleeve or accessory kit will prevent damages to your firepit.



# Manchester

## Foyer



### Chestnut Brown - Smooth

Fire pit  
Chestnut Brown / Chocolate Brown



Cap  
Chocolate Brown



### Shale Grey - Smooth

Fire pit  
Shale Grey / Onyx Black



Cap  
Onyx Black

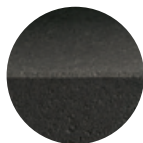

Pre-assembled sections (sold separately).  
The Chestnut Brown & Shale Grey fireplace differ both in color & slightly in design.

The Chestnut Brown uses Bullnose caps while the Shale grey uses Raffinato 14x28 caps. Please refer to the Techo-Spec or on our website for details.

### Chestnut Brown

	Top Section	Bottom Section	Woodboxes
in	53 3/8 x 52 x 32	43 1/2 x 60 1/8 x 44	30 3/8 x 34 x 36 5/8
mm	1 356 x 1 321 x 813	1 105 x 1 527 x 1 118	772 x 864 x 930

### Shale Grey

	Top Section	Bottom Section	Woodboxes
in	53 1/4 x 52 x 32	43 1/2 x 59 x 43	30 1/4 x 33 x 34
mm	1 353 x 1 321 x 813	1 105 x 1 499 x 1 092	768 x 838 x 864



Chestnut Brown



# Edges

## Re-define your outdoor spaces.

Discover the double-edged benefits of adding eye-catching stone trim to your outdoor spaces. Not only are they a strikingly simple way to define walkways, gardens and driveways, but they help keep grass, mulch and other landscaping elements in line at the same time. Attractive, functional and durable: sounds borderline perfect!

- 114 Borealis
- 115 Avignon
- 115 Brandon
- 116 Pietra
- 116 Raffinato
- 117 Röcka





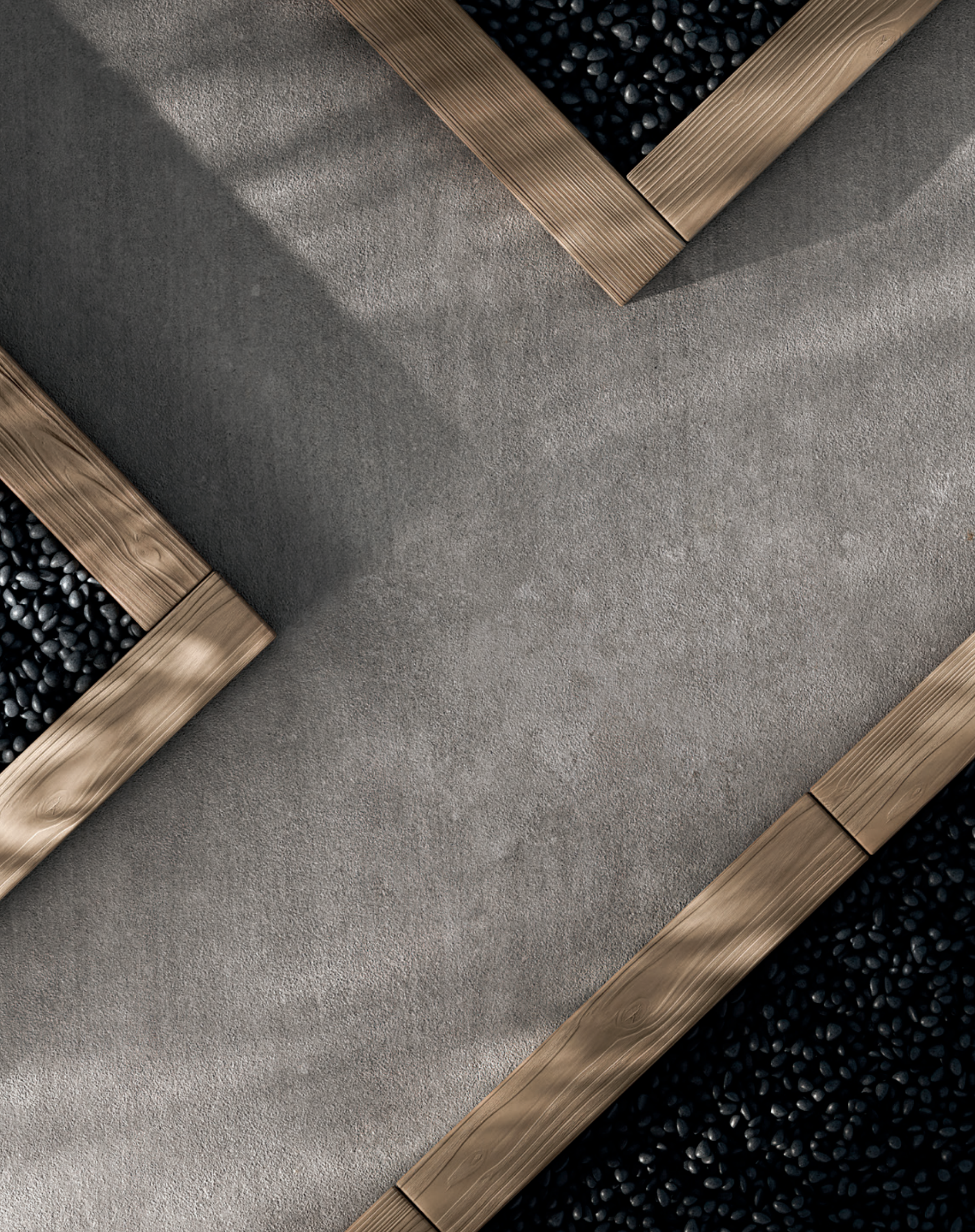



# Borealis



Smoked Pine



Hazelnut Brandy

Hazelnut Brandy

Depth 1: 7 3/4 in 197 mm Depth 2: 8 in 203 mm

6 x 48  
152 x 1 219





# Avignon

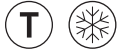

Chestnut Brown



Chestnut Brown



Champlain Grey

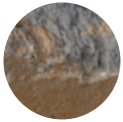

Sandlewood

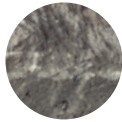

Shale Grey

Depth: 4 1/2 in 114 mm

7 x 12  
178 x 305



# Brandon



Chestnut Brown

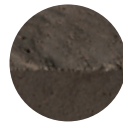

Chocolate Brown



Champlain Grey



Chestnut Brown

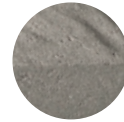

Shale Grey



Sandlewood

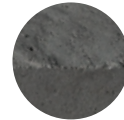

Onyx Black

Various sizes

Depth: 3 1/8 in 100 mm

7 1/16 x 8 7/8  
180 x 225



7 1/16 x 12 13/16  
180 x 325



7 1/16 x 16 3/4  
180 x 425





# Pietra

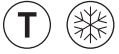

Shale Grey

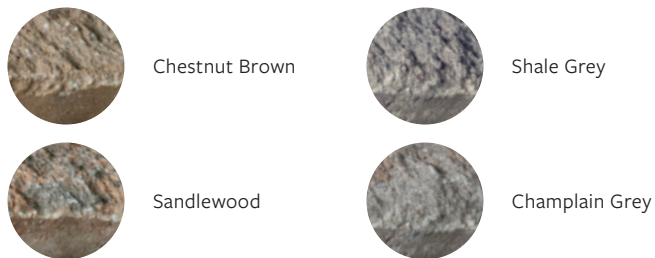

Various sizes

Depth: 3 1/8 in 80 mm

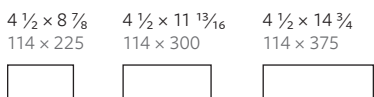

# Raffinato



Onyx Black

Smooth	Polished*	
		Beige Cream
		Greyed Nickel
		Shale Grey only available in Canada
		Onyx Black
90 mm ————— Depth: 9 13/16 in 249 mm	180 mm ————— Depth: 9 13/16 in 249 mm	Polished 90 mm ——— Depth: 9 3/4 in 248 mm
3 3/16 x 14 1/8 90 x 359	7 1/16 x 14 1/8 180 x 359	3 3/16 x 14 1/16 90 x 357

\*Polished is made-to-order, with a minimum order of 500 sq. ft. of Raffinato Polished wall. Deposit required.



# Röcka



Chocolate  
Brown



Rock Garden  
Brown



Riviera

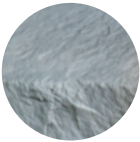

Riviera

Various sizes

Depth 1: 7 3/4 in 197 mm Depth 2: 8 in 203 mm

6 x 13 1/4  
152 x 337

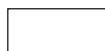

6 x 26 1/2  
152 x 673

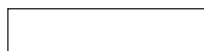

6 x 39 3/4  
152 x 1 010

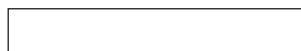



# Walls

## Take landscape design to new heights

Our tasteful walls are designed to do more than build up the visual interest of your yard, garden and patio (though they're great at that, too). When creativity comes calling, play with different textures and finishes to create custom features like bars, benches, kitchens and firepits. And to keep it all looking seamlessly coordinated, our wall colors are perfectly matched with our other product collections.

- 120 Fascia Iconic
- 121 Fascia Rosemont
- 122 Borealis
- 124 Brandon
- 126 Graphix
- 128 G-Force
- 129 Prescott
- 130 Mini-Creta Architectural
- 132 Raffinato
- 134 Röcka
- 136 Semma
- 137 Skyscraper
- 138 Travertina Raw









# Iconic

## Fascia Wall Collection



Rock Garden Brown



Rock Garden Brown



Victoria

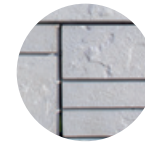

Riviera

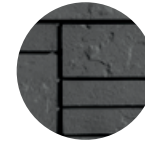

Onyx Black

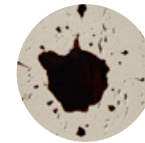

Factory-applied protection for stain resistance

Core - Single-sided  \_\_\_\_\_  
Depth: 9 1/4 in 235 mm

5 7/8 x 7 7/8  
150 x 200



Core - Double-sided  \_\_\_\_\_  
Depth: 11 1/16 in 281 mm

5 7/8 x 7 7/8  
150 x 200



Base Unit  \_\_\_\_\_  
Depth: 12 in 305 mm

2 3/8 x 23 5/8  
60 x 600



The Fascia Wall collection allows you to customize your next outdoor space. You can choose between a one-sided, or double-sided wall, allowing you to adapt the product to your project needs and personalize it to your style. From garden walls to outdoor features, and everything in between, the Fascia Wall Collection will bring your landscape design to life.

All pieces are sold separately. Core blocks & Base units are required, Iconic & Rosemont Fascia & Corner units have the same dimensions.





Rock Garden Brown

# Rosemont

## Fascia Wall Collection

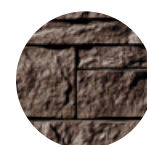

Chocolate Brown



Rock Garden Brown

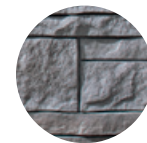

Riviera

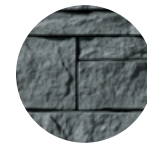

Azzurro

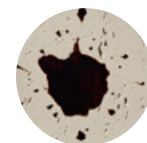

**KLE**  
Factory-applied protection for stain resistance

Fascia —————  
Depth: 2 3/4 in 70 mm

5 7/8 x 26  
150 x 660



Left Corner —————  
Depth: 2 3/4 in 70 mm

5 7/8 x 23 1/4  
150 x 590



Right Corner —————  
Depth: 2 3/4 in 70 mm

5 7/8 x 23 1/4  
150 x 590



All pieces are sold separately. Core blocks & Base units are required, Iconic & Rosemont Fascia & Corner units have the same dimensions.



# Borealis



Smoked Pine

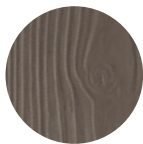

Hazelnut Brandy



Hazelnut Brandy

Double-sided Wall

Depth 1: 7 3/4 in 197 mm    Depth 2: 8 in 203 mm

6 x 48  
152 x 1 219













# Brandon



Onyx Black



Chestnut Brown



Sandlewood



Champlain Grey



Shale Grey



Onyx Black

90 mm Corner  
Depth: 9 13/16 in 250 mm

3 3/16 x 14 3/16  
90 x 360



90 mm Double-sided Wall  
Depth: 9 13/16 in 250 mm

Side 1: 3 3/16 x 11 1/4  
Side 2: 3 3/16 x 9 5/8

90 x 285  
90 x 245

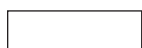

Side 1: 3 3/16 x 14 3/8  
Side 2: 3 3/16 x 12 13/16

90 x 365  
90 x 325

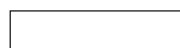

Side 1: 3 3/16 x 15 15/16  
Side 2: 3 3/16 x 14 3/8

90 x 405  
90 x 365



180 mm Double-sided Wall  
Depth: 9 13/16 in 250 mm

Side 1: 7 1/16 x 11 1/4  
Side 2: 7 1/16 x 9 5/8

180 x 285  
180 x 245



Side 1: 7 1/16 x 14 3/8  
Side 2: 7 1/16 x 12 13/16

180 x 365  
180 x 325



Side 1: 7 1/16 x 15 15/16  
Side 2: 7 1/16 x 14 3/8

180 x 405  
180 x 365



180 mm Corner  
Depth: 9 13/16 in 250 mm

7 1/16 x 14 3/16  
180 x 360





# Graphix



Beige Cream



Greyed Nickel



Onyx Black



Greyed Nickel

Double-sided Wall - Various depths

Depth: 9 1/16 - 10 1/16 - 11 - 8 1/16 in 230 - 255 - 280 - 205 mm

Smooth 2 15/16 x 20  
75 x 508

Smooth 2 15/16 x 20  
75 x 508

Smooth 2 15/16 x 20  
75 x 508

Split face 2 15/16 x 20  
75 x 508



One in 4 pieces is split face & 3 in 4 pieces are smooth





Greyed Nickel & Onyx Black



# G-Force

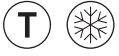

Chestnut Brown



Sandalwood



Champlain Grey



Shale Grey

Wall \_\_\_\_\_

Depth: 11  $\frac{7}{16}$  in 290 mm

8 x 18 x 8  $\frac{5}{8}$   
203 x 457 x 219



Corner \_\_\_\_\_

Depth: 9 in 229 mm

8 x 18  
203 x 457





# Prescott



Rock Garden Brown



Rock Garden Brown



Victoria

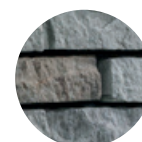

Riviera

2.25" Double-sided Wall \_\_\_\_\_  
 Depth: 9 13/16 in 250 mm

2 1/4 x 9 x 7 7/16  
 57 x 229 x 189



2 1/4 x 12 x 10 7/16  
 57 x 305 x 265



2 1/4 x 15 x 13 7/16  
 57 x 381 x 341

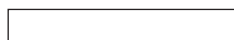

2.25" Corner \_\_\_\_\_  
 Depth: 9 13/16 in 250 mm

2 1/4 x 14 3/16  
 57 x 360

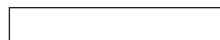

4.5" Double-sided Wall \_\_\_\_\_  
 Depth: 9 13/16 in 250 mm

4 1/2 x 9 x 7 7/16  
 114 x 229 x 189



4 1/2 x 12 x 10 7/16  
 114 x 305 x 265



4 1/2 x 15 x 13 7/16  
 114 x 381 x 341



4.5" Corner \_\_\_\_\_  
 Depth: 9 13/16 in 250 mm

4 1/2 x 14 3/16  
 114 x 360







Mini-Creta Architectural Chestnut Brown

6" Double-sided Architectural Wall & Corner - Various sizes

Depth: 9 1/16 in 250 mm

Side 1: 5 7/8 x 9 1/16  
Side 2: 5 7/8 x 7 1/16  
150 x 230  
150 x 180

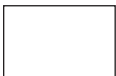

Side 1: 5 7/8 x 11 13/16  
Side 2: 5 7/8 x 9 13/16  
150 x 300  
150 x 250

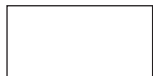

Side 1: 5 7/8 x 11 13/16  
Side 2: 5 7/8 x 11 13/16  
150 x 300  
150 x 300



Side 1: 5 7/8 x 14 3/4  
Side 2: 5 7/8 x 12 13/16  
150 x 375  
150 x 325



Side 1: 5 7/8 x 14 3/4  
Side 2: 5 7/8 x 13 3/4  
150 x 375  
150 x 350



Pillar 24 x 6" Architectural

Depth: 8 in 203 mm

5 7/8 x 16  
150 x 406





# Mini-Creta

## Architectural



Mini-Creta Architectural Sandlemwood

### Mini-Creta Architectural

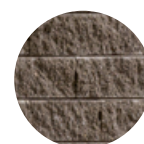

Chocolate Brown  
only available  
in 3" walls



Chestnut Brown



Sandlewood



Champlain Grey

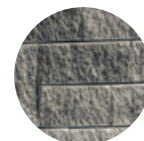

Shale Grey

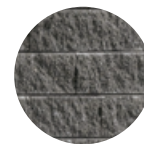

Onyx Black  
only available  
in 3" walls

### 3" Double-sided Architectural Wall & Corner - Various sizes

Depth: 9 1/16 in 250 mm

Side 1: 2 15/16 x 9 1/16  
Side 2: 2 15/16 x 7 1/16  
75 x 230  
75 x 180

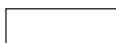

Side 1: 2 15/16 x 11 13/16  
Side 2: 2 15/16 x 9 13/16  
75 x 300  
75 x 250

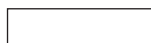

Side 1: 2 15/16 x 11 13/16  
Side 2: 2 15/16 x 11 13/16  
75 x 300  
75 x 300

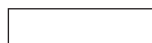

Side 1: 2 15/16 x 14 3/4  
Side 2: 2 15/16 x 12 13/16  
75 x 375  
75 x 325

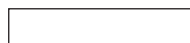

Side 1: 2 15/16 x 14 3/4  
Side 2: 2 15/16 x 13 3/4  
75 x 375  
75 x 350

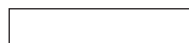

### Pillar 24" x 3" Architectural

Depth: 8 in 203 mm

2 15/16 x 16  
75 x 406

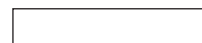



# Raffinato

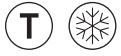

Smooth

Beige Cream



Greyed Nickel



Shale Grey  
only available  
in Canada



Onyx Black



Polished\*

Beige Cream



Greyed Nickel



Onyx Black

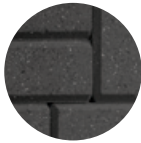

\*Polished is made-to-order, minimum order of 500 sq. ft. Deposit required.

\*\*Polished finish is only available on a single side of the wall. Polished units are 9 3/4 in. (248 mm) in Depth.



Beige Cream - Smooth

\*\*90 mm Double-sided Wall

\*\*\*Depth: 9 13/16 in 249 mm

Side 1: 3 3/16 x 15 5/8  
90 x 397      Side 2: 3 3/16 x 14 1/4  
90 x 362



90 mm Corner

\*\*\*Depth: 9 13/16 in 249 mm

3 3/16 x 14 1/8  
90 x 359



\*\*180 mm Double-sided Wall

\*\*\*Depth: 9 13/16 in 249 mm

Side 1: 7 1/16 x 15 5/8  
180 x 397      Side 2: 7 1/16 x 14 1/4  
180 x 362



180 mm Corner

\*\*\*Depth: 9 13/16 in 249 mm

7 1/16 x 14 1/8  
180 x 359



\*\*\*For Corners: Polished units are 9 3/4 in (248 mm) Depth & 14 1/16 in (357 mm) length.





Greyed Nickel & Onyx Black accent in Smooth - paired with Raffinato Cap





Riviera

Chocolate  
Brown



Rock Garden  
Brown



Riviera



Various sizes - Double-sided Wall

Depth 1: 7 3/4 in 197 mm    Depth 2: 8 in 203 mm

6 x 13 1/4  
152 x 337



6 x 26 1/2  
152 x 673



6 x 39 3/4  
152 x 1 010





# Röcka





# Semma

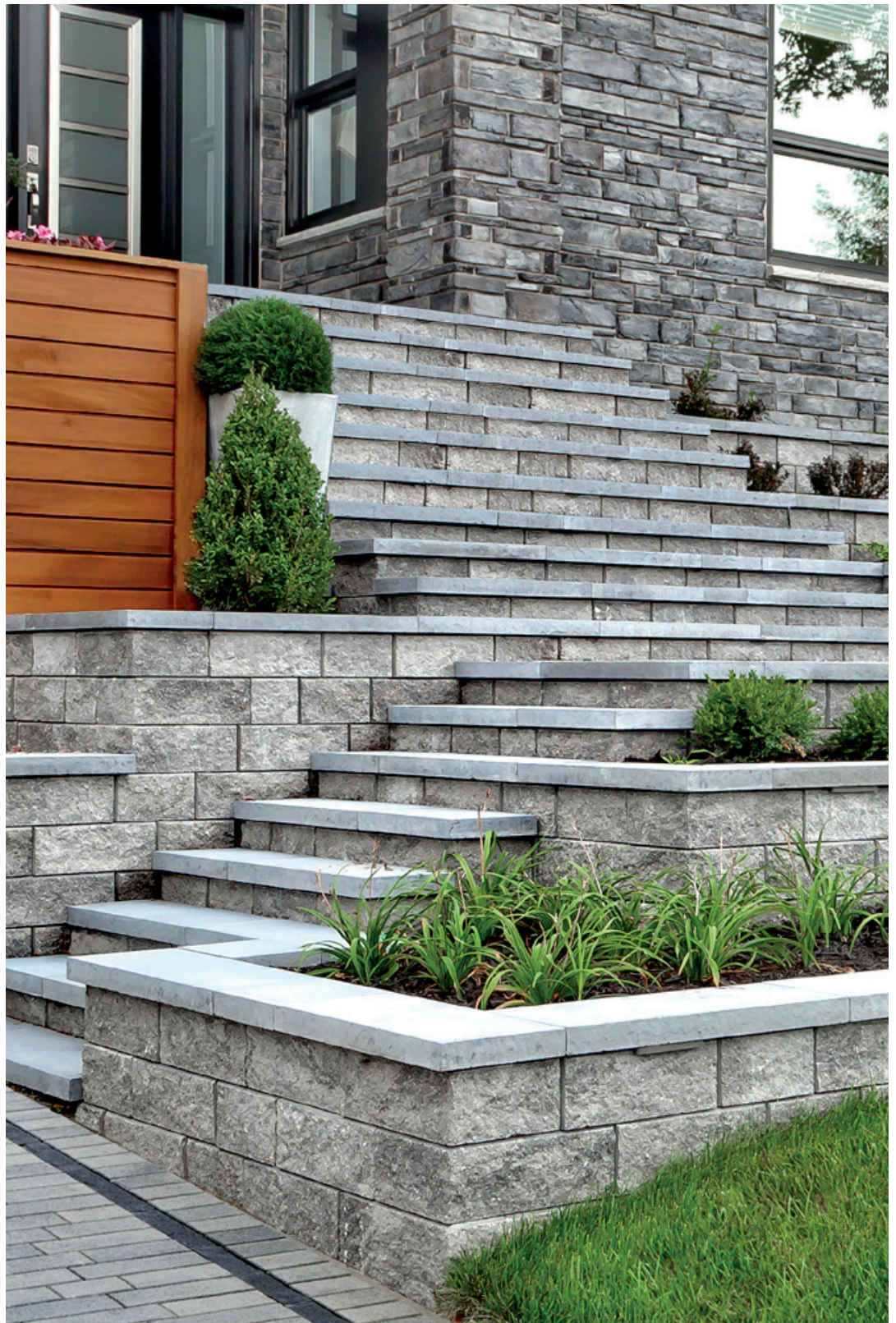
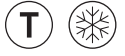

Shale Grey

Chestnut Brown



Sandlewood



Champlain Grey



Shale Grey

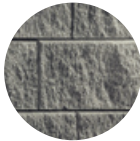

Wall & Corner - Double-sided Wall

Depth: 11 in 279 mm

Side 1:  $5 \frac{7}{8} \times 16$   
150 x 406

Side 2:  $5 \frac{7}{8} \times 10 \frac{1}{2}$   
150 x 266



Pillar

Depth: 10 1/2 in 266 mm

$5 \frac{7}{8} \times 16$   
150 x 406





# Skyscraper

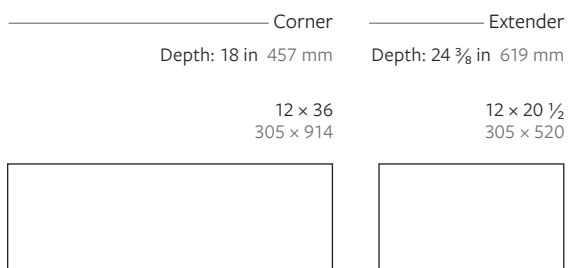
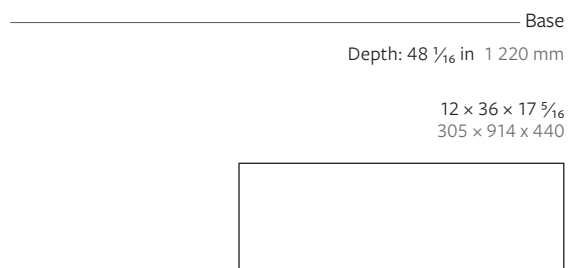
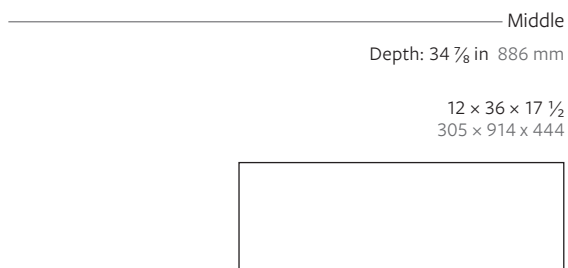
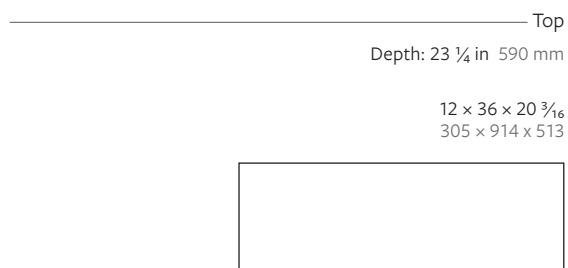

Shale Grey



# Travertina Raw



Rock Garden Brown



Ivory



Riviera

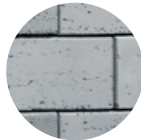

Riviera paired with Travertina Raw cap

Double-sided Wall

Depth: 7 1/4 in 202 mm

6 x 15 7/8  
152 x 403



Corner

Depth: 7 1/4 in 202 mm

6 x 15 7/8  
152 x 403







Ivory paired with Travertina Raw cap & slab



# Caps

## Capping off the great outdoors.

When upgrading your outdoor living areas, top them off right with the perfect finishing touches. Our color-coordinated caps and copings add the crowning touch to pool edges, stairs, walls, firepits and more — and best of all, they're as protective as they are attractive.

- 142 Compatibility Chart
- 144 Bali Travertina Raw
- 144 Bullnose
- 145 Bullnose Grande
- 145 Portofino
- 146 Architectural
- 146 Brandon
- 147 Graphix
- 147 Piedimonte
- 148 Raffinato
- 149 Travertina Raw
- 149 York





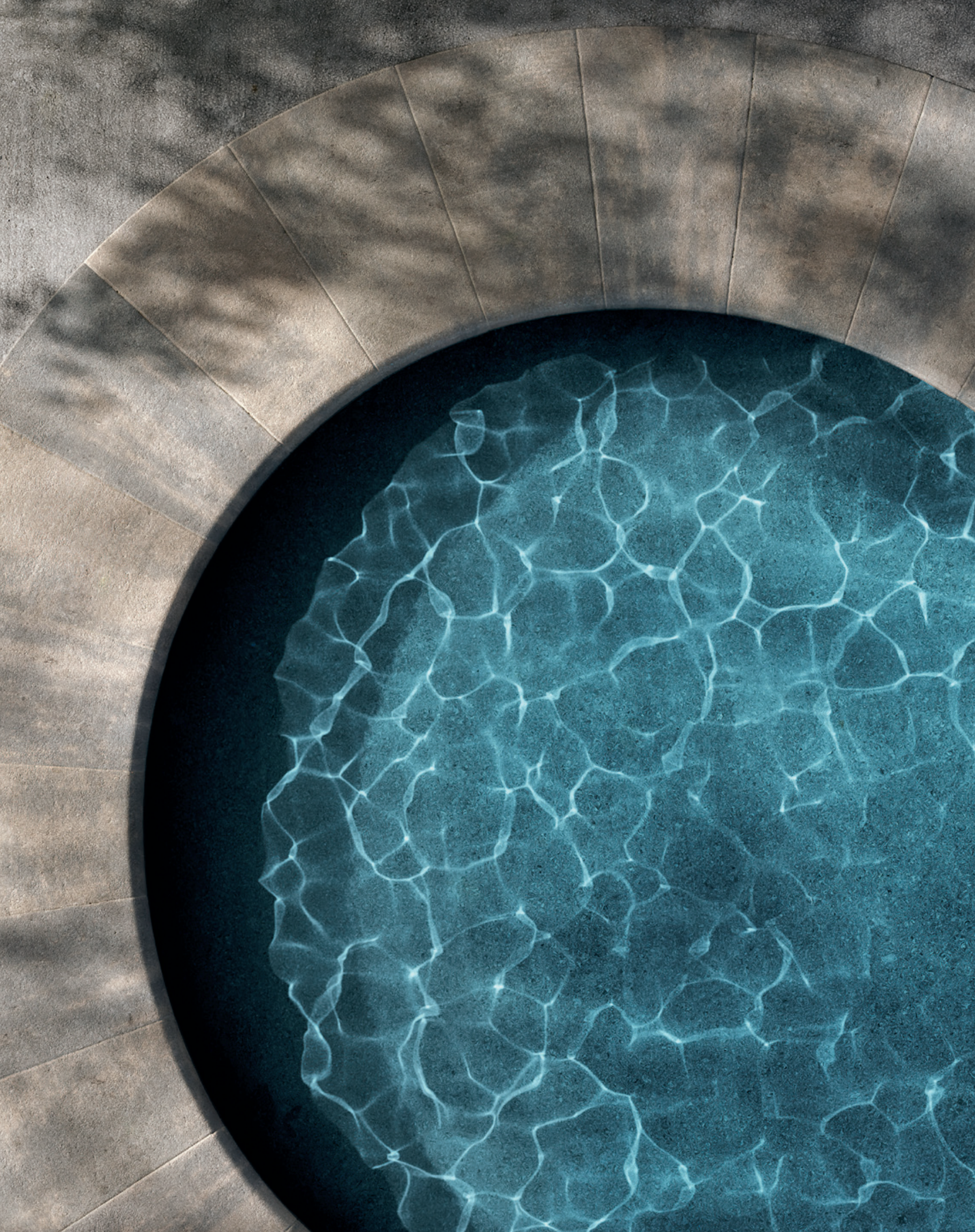





Victorien paver in Onyx Black paired with Raffinato wall & cap in Greyed Nickel & Onyx Black



# Compatibility Chart

Walls & Pillars	Caps															
	Architectural Cap	Brandon Cap	Bullnose	Bullnose Grande	Graphix Cap	Pacific	Piedimonte	Piedimonte 28" x 28"	Portofino	Raffinato 60 mm	Raffinato 90 mm	Travertina Raw 14" x 28"	York	York 28" x 28"	York 32" x 32"	
Borealis (does not require a cap)																
Brandon 90 & 180 mm		x	x	x		x	x		x	x	x	x	x			
Brandon 90 & 180 mm pillar								x		x	x	x		x		
Fascia Wall Collection - single-sided	x	x	x	x	x	x	x		x	x	x	x	x			
Fascia Wall Collection - double-sided									x							
G-Force					x		x			x	x	x				
Graphix					x		x			x	x	x				
Mini-Creta Collection	x	x	x	x		x	x		x	x	x	x	x			
Mini-Creta Pillar 24" Collection								x		x	x	x		x		
Prescott Collection							x		x	x	x	x	x			
Prescott Pillar Collection								x		x	x	x		x		
Raffinato Collection					x		x			x	x	x				
Raffinato Pillar Collection				x				x		x	x	x				
Röcka (does not require a cap)																
Semma	x	x	x		x	x	x		x	x	x	x	x			
Semma Pillar										x		x				x
Skyscraper										x	x					
Travertina Raw	x	x	x	x	x	x	x		x	x	x	x	x			
Travertina Raw pillar										x	x	x		x		

NOTE: The combinations shown in this chart are not complete. Other possible combinations exist.

Applications	Caps																				
	Architectural Cap	Bali Travertina Raw	Brandon Cap	Bullnose	Bullnose Grande	Graphix Cap	Pacific	Piedimonte 14" x 30"	Piedimonte 28" x 28"	Portofino	Raffinato 60 mm	Raffinato 90 mm	Travertina Raw 14" x 28"	York wall caps 16", 32", 48"	York 14" x 48"	York 24" x 36"	York 28" x 28"	York 32" x 32"	Blu 45 mm	Venetian	
Step	x		x	x	x	x		x		x	x	x	x	x	x						
Concrete & step overlay system							x												x		x
Pool coping		x		x	x		x	x		x	x	x	x	x							
Wall single-sided	x		x	x	x	x	x	x		x	x	x	x	x	x						
Wall double-sided	x					x		x		x	x	x	x	x	x						
Counter top								x	x					x			x	x			
Pillar									x		x		x				x	x			



# Bali Travertina Raw



Ivory

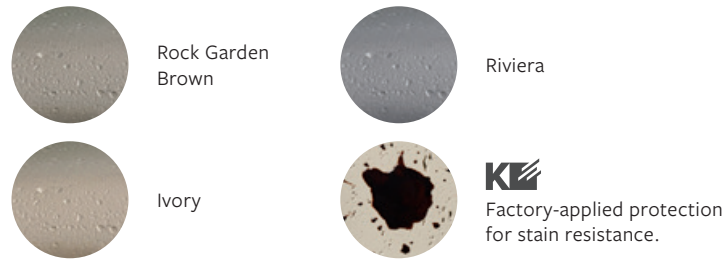

Depth: 12 in 305 mm

2 1/4 x 2 3/4 x 16  
57 x 70 x 406



# Bullnose



Onyx Black



Depth: 12 in 305 mm

2 3/8 x 5 7/8  
60 x 150





# Bullnose Grande

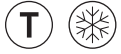

Greyed Nickel



Beige Cream

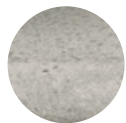

Greyed Nickel

Depth: 14 1/16 in 357 mm

2 3/16 x 29 1/2  
56 x 750



# Portofino

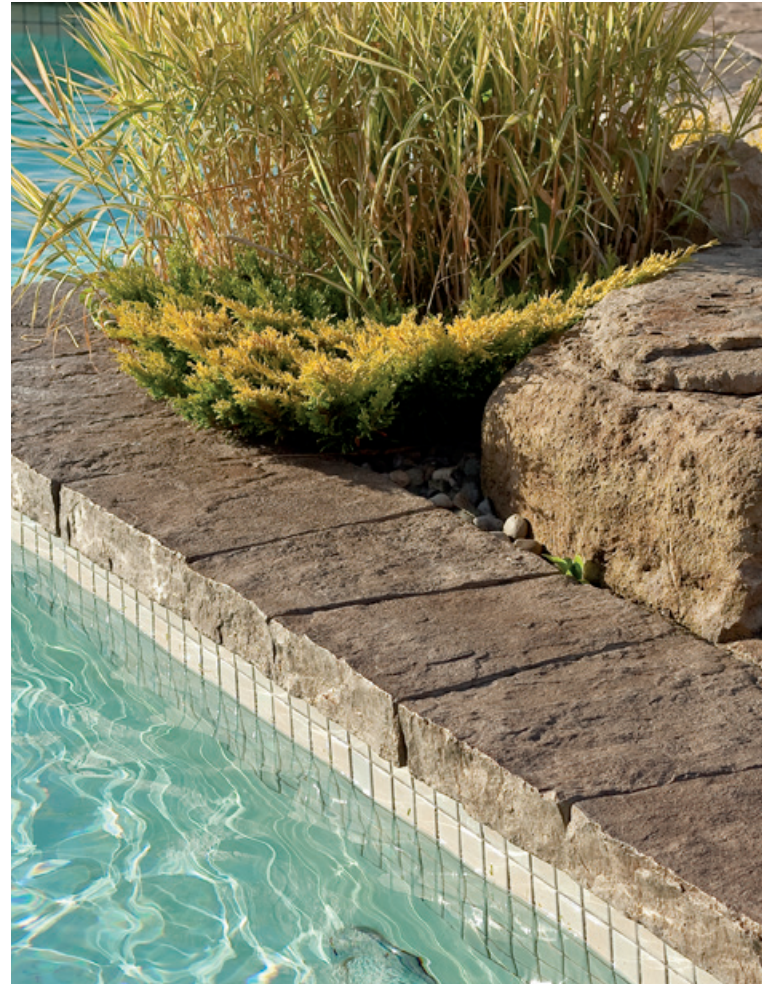

Chocolate Brown



Chocolate Brown

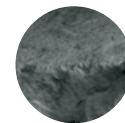

Azzurro



Rock Garden  
Brown

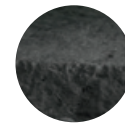

Onyx Black



Riviera

Various sizes

Depth: 14 1/2 in 368 mm

2 1/4 x 11 3/4 x 9 3/8  
57 x 298 x 238

2 1/4 x 15 7/8 x 13 3/4  
57 x 403 x 349

2 1/4 x 18 13/16 x 16 1/2  
57 x 478 x 419

2 1/4 x 19 x 19  
57 x 483 x 483





# Architectural

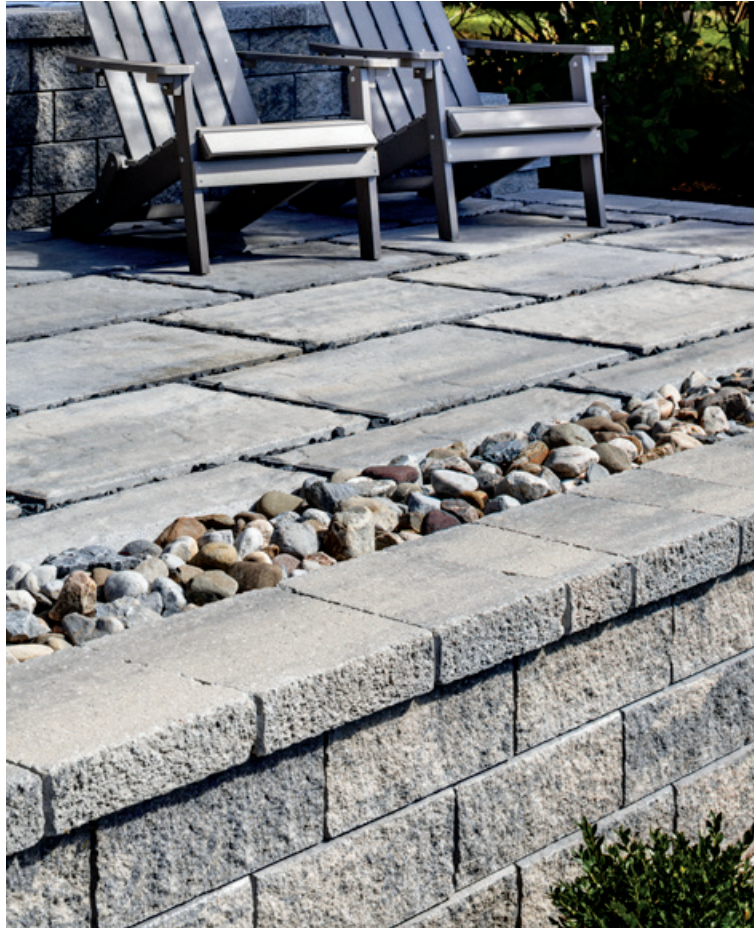
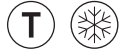

Shale Grey

# Brandon



Champlain Grey



Depth: 12 1/2 in 317 mm

2 15/16 x 8 7/8 x 6 1/2  
75 x 225 x 165



2 15/16 x 11 13/16 x 9 7/16  
75 x 300 x 240



2 15/16 x 14 3/4 x 12 3/8  
75 x 375 x 315



2 15/16 x 14 3/4 x 13 7/16  
75 x 375 x 345



Depth: 14 in 356 mm

3 7/16 x 16  
90 x 406





# Graphix

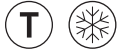

Beige Cream

Smooth Side   Split Face Side



Beige Cream



Greyed Nickel



Onyx Black

Depth: 14 in 356 mm

2 15/16 x 20  
75 x 508

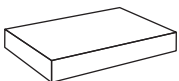

# Piedimonte

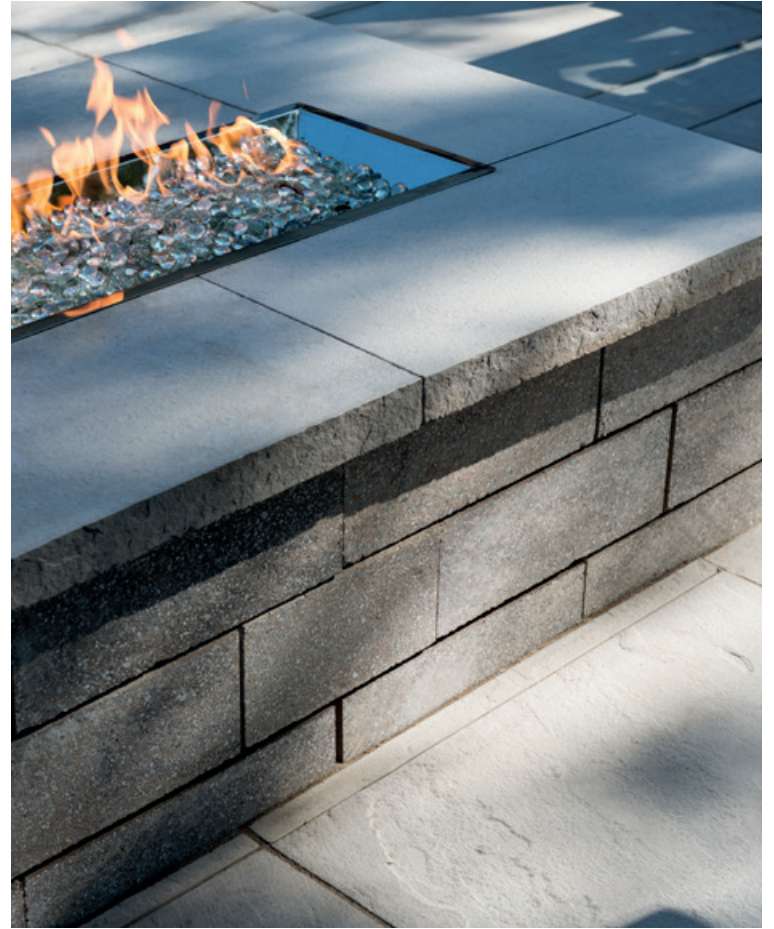

Riviera



Rock Garden Brown

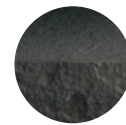

Onyx Black

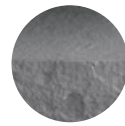

Riviera

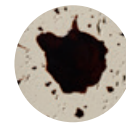

**KLE**  
Factory-applied  
protection for stain  
resistance.

14" x 30"

Depth: 14 in 356 mm

2 1/4 x 30  
57 x 762

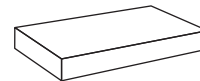

28" x 28"

Depth: 28 in 711 mm

2 7/8 x 28  
73 x 711





# Raffinato

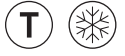

Onyx Black



Chestnut Brown

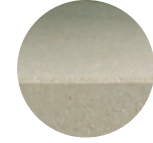

Beige Cream



Champlain Grey

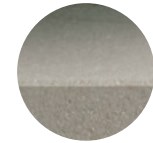

Greyed Nickel



Shale Grey

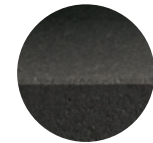

Onyx Black

60 mm  
Depth: 14 in 356 mm

$2\frac{3}{8} \times 28$   
60 x 711



148

90 mm  
Depth: 14 in 356 mm

$3\frac{1}{6} \times 28$   
90 x 711





# Travertina Raw

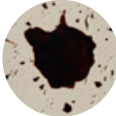

Ivory

	Rock Garden Brown		Riviera
	Ivory		<b>KE</b> Factory-applied protection for stain resistance

14" x 28" \_\_\_\_\_  
Depth: 14 in 356 mm

2 1/4 x 28  
57 x 711



# York



Riviera

	Chocolate Brown		Ivory		Onyx Black
	Rock Garden Brown		Riviera		<b>KE</b> Factory-applied protection for stain resistance.

28" x 28" Pillar Cap \_\_\_\_\_      32" x 32" Pillar Cap \_\_\_\_\_      Counter Top \_\_\_\_\_  
Depth: 28 3/4 in 730 mm      Depth: 32 in 813 mm      Depth: 24 in 610 mm

3 1/2 x 28 3/4      3 1/2 x 32      2 1/4 x 36  
89 x 730      89 x 813      57 x 914



16", 32" & 48" \_\_\_\_\_      Wall Cap \_\_\_\_\_  
Depth: 14 in 356 mm      Depth: 14 in 356 mm

2 1/4 x 16 57 x 406	2 1/4 x 32 57 x 813	2 1/4 x 48 57 x 1 219	2 1/4 x 48 57 x 1 219
------------------------	------------------------	--------------------------	--------------------------





# Steps

## Step up your curb appeal.

Elevating your landscape design is simple when you follow the right steps. Our stone steps offer a beautiful way to offset spaces, creating natural paths and visual interest in your yards and gardens. Or, boost your home's curb appeal by welcoming guests with a show-stopping entrance right up front. Wherever they lead, our maintenance-free overlay systems are exclusively designed to step in and give new life to timeworn poured concrete.

- 152 Borealis
- 153 Maya
- 154 Raffinato
- 155 Röcka
- 156 York
- 157 Venetian









# Borealis

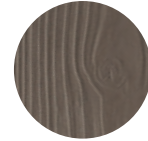

Smoked Pine

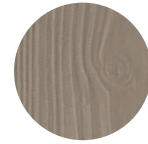

Hazelnut Brandy

---

Height: 6 in 152 mm

15 3/4 x 16 x 48  
400 x 406 x 1 219





# Maya



Riviera



Chocolate Brown



Rock Garden Brown

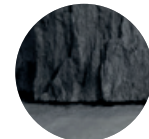

Riviera

Height: 6 in 152 mm

32 x 48  
813 x 1 219

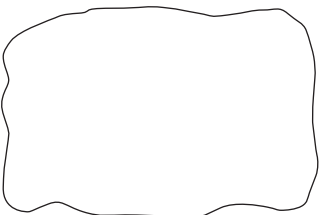



# Raffinato

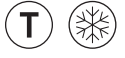

Greyed Nickel

Height: 7 1/16 in 180 mm

14 1/2 x 42  
368 x 1 067





# Röcka

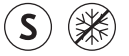

Chocolate Brown



Rock Garden Brown



Riviera



48" Double-sided

Height: 6 in 152 mm

14 7/8 x 14 1/8 x 48  
378 x 359 x 1 219



60"

Height: 6 in 152 mm

15 1/4 x 14 5/8 x 60  
387 x 371 x 1 524



Riviera paired with Röcka wall



# York

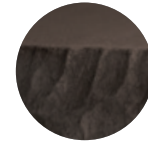

Chocolate Brown



Rock Garden Brown

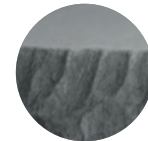

Riviera

---

Height: 6 in 152 mm

15 x 60  
381 x 1 524





# Venetian

## Cap & riser



Venetian in Chestnut Brown paired with Blu 45 mm in Sandlewood



Cap

Height (Smooth) 1 1/4 in 50 mm  
 Height (Slate) 1 3/4 in 45 mm

Smooth: 14 x 15 5/8  
 Slate: 14 x 16

Smooth: 356 x 397  
 Slate: 356 x 406



Riser

Height (Smooth) 1 1/4 in 50 mm  
 Height (Slate) 1 3/4 in 45 mm

Smooth: 7 x 15 5/8  
 Slate: 7 x 16

Smooth: 178 x 397  
 Slate: 178 x 406





# Color Coordinate

	Merlot	Chocolate Brown	Chestnut Brown	Sandlewood	Champlain Grey	Beige Cream	Greyed Nickel	Grey	Shale Grey	Onyx Black	Smoked Pine	Rock Garden Brown	Hazelnut Brandy	Ivory	Victoria	Riviera	Azzurro
<b>Slabs</b>																	
Aberdeen Klean-Bloc												X					X
Blu 45 mm Overlay System - Slate			X	X	X				X								
Blu 45 mm Overlay System - Smooth			X		X	X	X		X	X							
Blu 60 mm - Slate <sup>Ⓢ</sup>			X	E	X				X								
Blu 60 mm - HD <sup>2</sup> Slate <sup>Ⓢ</sup>			●	E	●				●								
Blu Grande - Slate			X	E	X				X								
Blu Grande - HD <sup>2</sup> Slate			●	E	●				●								
Blu 60 mm (6 x 13) - Slate <sup>Ⓢ</sup>		X	X	E	X				X	X							
Blu 60 mm (6 x 13) - HD <sup>2</sup> Slate <sup>Ⓢ</sup>			●	E	●				●	●							
Blu 60 mm Smooth <sup>Ⓢ</sup>			X		X	X	X		X	X							
Blu 60 mm HD <sup>2</sup> Smooth <sup>Ⓢ</sup>			X		X		X		X	X							
Blu 60 mm (6 x 13) - Smooth <sup>Ⓢ</sup>		X	X		X	X	X		X	X							
Blu 60 mm (6 x 13) - HD <sup>2</sup> Smooth <sup>Ⓢ</sup>			X		X		X		X	X							
Blu Grande - Smooth			X		X	X	X		X	X							
Blu Grande HD <sup>2</sup> Smooth			X		X		X		X								
Blu 60 mm & Grande - Polished			X			X	X		X	X							
Borealis Klean-Bloc											X		X			X	
Borealis Stepping Stones													X				
Everest HD <sup>2</sup> +	X		X				X		X								
Hexa HD <sup>2</sup> +			X			X	X		X	X							
Inca HD <sup>2</sup>															X	X	
Industria - 600 Series HD <sup>2</sup>			X			X	X		X	X							
Maya															X	X	
Ocean Grande HD <sup>2</sup>						X	X										
Pacific Overlay System and cap			X		X				X								
Para HD <sup>2</sup>						X	X			X							
Travertina Raw Klean-Bloc												X		X		X	

## Pavers

Antika - Smooth <sup>Ⓢ</sup>		X	X	X					X	X							
Aquastorm <sup>Ⓢ</sup>								X									
Blu 80 mm - Slate <sup>Ⓢ</sup>			X	X	X				X								
Blu 80 mm - HD <sup>2</sup> Slate <sup>Ⓢ</sup>			●	E	●				●								
Blu 80 mm (6 x 13) - Slate <sup>Ⓢ</sup>		X	X		X				X	X							
Blu 80 mm (6 x 13) - HD <sup>2</sup> Slate <sup>Ⓢ</sup>			●		●				●	●							
Blu 80 mm - Smooth <sup>Ⓢ</sup>			X		X	X	X		X	X							
Blu 80 mm - HD <sup>2</sup> Smooth <sup>Ⓢ</sup>			X		X		X		X	X							
Blu 80 mm (6 x 13) - Smooth <sup>Ⓢ</sup>		X	X		X	X	X		X	X							
Blu 80 mm (6 x 13) - HD <sup>2</sup> Smooth <sup>Ⓢ</sup>			X		X		X		X	X							
Blu 80 mm - Polished (On order only) <sup>Ⓢ</sup>			X			X	X		X	X							
Diamond HD <sup>2</sup>			X			X	X		X	X							
Eva			X	X	X				X								
Hexa HD <sup>2</sup> +			X			X	X		X	X							
Hydra <sup>Ⓢ</sup>								X									
Industria Collection HD <sup>2</sup>			X			X	X		X	X							
Linea			X		X				X	X							
Mika Klean-Bloc <sup>Ⓢ</sup>										X		X					
Mista Random <sup>Ⓢ</sup>			X	X	X				X								
Pure <sup>Ⓢ</sup>			X	X	X				X								
Sleek HD <sup>2</sup>			X		X	X	X		X	X							
Squadra - Slate	X		X						X	X							
Travertina Raw Klean-Bloc <sup>Ⓢ</sup>												X		X		X	
Valet <sup>Ⓢ</sup>			X		X				X	X							
Victorien 60 mm		X							X	X							
Villagio <sup>Ⓢ</sup>	X	X	X	X	X				X	X							
Westmount HD <sup>2</sup> +	X	X							X	X							



## Outdoor Features

	Merlot	Chocolate Brown	Chestnut Brown	Sandlewood	Champlain Grey	Beige Cream	Greyed Nickel	Grey	Shale Grey	Onyx Black	Smoked Pine	Rock Garden Brown	Hazelnut Brandy	Ivory	Victoria	Riviera	Azzurro
Manchester Foyer - Smooth			x						x								
Brandon Firepit			x						x								
Prescott Firepit												x				x	
Raffinato Firepit							x			x							
Valencia Firepit			x	x	x				x								

## Edges

Avignon			x	x	x				x								
Borealis											x		x				
Brandon		x	x	x	x				x	x							
Pietra			x	x	x				x								
Raffinato Collection						x	x		C	x							
Röcka		x										x				x	

## Walls & Pillars

Borealis											x		x				
Brandon			x	x	x				x	x							
Fascia Wall Collection Klean-Bloc		x								x		x			x	x	x
G-Force			x	x	x				x								
Graphix						x	x			x							
Mini-Creta Architectural Wall		x	x	x	x				x								
Mini-Creta Architectural Pillars			x	x	x				x								
Prescott Collection												x			x	x	
Raffinato Collection						x	x		C	x							
Röcka		x										x					x
Semma			x	x	x				x								
Skyscraper			x						x								
Travertina Raw												x		x		x	

## Steps, caps & overlay system

Architectural Cap		x	x	x	x				x	x							
Bali Travertina Raw Cap Klean-Bloc												x		x		x	
Brandon Cap			x	x	x				x	x							
Bullnose Cap		x	x		x				x	x							
Bullnose Grande Cap						x	x										
Graphix Cap						x	x			x							
Piedimonte Cap Klean-Bloc										x		x					x
Portofino Cap		x								x		x				x	x
Raffinato Cap Collection			x		x	x	x		C	x							
Travertina Raw Cap Klean-Bloc												x		x		x	
York Collection Klean-Bloc		x								x		x		x		x	
Borealis Step											x		x				
Maya Step		x										x				x	
Raffinato Step						x	x		C	x							
Röcka Step		x										x				x	
York Step		x										x				x	
Venetian Overlay System - Slate			x	x	x				x								
Venetian Overlay System - Smooth			x	x	x				x								

For an authentic look, each color option is composed of a variety of darker & lighter tones. Natural ingredients such as granite are present within the recipe to allow for a range in tones, veining & textures from one stone to another. Final color selection should be made with your contractor from product samples or at your local dealer from stocked product. This color chart serves as a guide for color selection across product lines.

X Available    ⊕ Permeable    ● Available only in USA  
 E Available only in Eastern USA    C Available only in Canada

Eastern USA encompasses these states: CT, DE, MA, MD, ME, NC, NH, NJ, NY, Eastern PA, RI, SC, VA & VT



## A STANDARD OF CARE

The care of high quality concrete products is similar to the care of any product left in the environment 365 days and nights per year. Very mild cleaning using detergents, water and product specific chemicals is necessary and similar to cleaning patio furniture, a vehicle's chrome, plastic, or paint, etc. in order to enhance their presence and charm. Protectant of all types (high, middle, and low sheen, pigmented/tinted, penetrating or film forming) are available for additional protection from acid rain, stains and nature's worst. To get the most from your investments take care of them and they'll take care of you.

For any questions on industry-specific cleaners and protectant, see your local hardscape dealer/distributor, contact your contractor, contact us or search online.

It is contrary to Techo-Bloc's SOP (Standard Operating Procedures) to be involved in the care of a mature pavement or retaining structure. Care as mentioned above is the responsibility of the owner for any and all outdoor products.

NCMA disclaimer: "In areas where segmental retaining walls will be repeatedly exposed to snow (such as from snow plowing operations) consider periodically applying sealants or water repelling chemicals (silane or siloxane compounds) to the wall surface."

## COLOR

Due to the inherent nature of printed literature and current digital media, Techo-Bloc cannot guarantee specific colour matching to printed representations of its colour swatches.

Each color option is composed of a variety of darker and lighter tones. Natural ingredients such as granite are present within the recipe to allow for a range in tones, veining and textures from one stone to another. Therefore, colours samples shown are approximate representations of our standard colours and actual product colours may vary.

Final color selection should be made at your local dealer from stocked product. Techo-Bloc always recommends immediately verifying the product and colour upon reception. If there are any discrepancies, contact your local dealer before continuing your project. Installation of the product constitutes your acceptance of the product as is.

## EFFLORESCENCE

This warranty does not apply to efflorescence. Efflorescence is a natural occurring process in all concrete products which sometimes appears in the form of a white powdery film on the pavement surface. Efflorescence is more perceivable in darker colours such as Onyx Black and Chocolate

Brown as there is a higher level of contrast than with other blended colours. It does not, in any way, compromise the functionality or the structural integrity of the product. Although efflorescence cannot be prevented, it will wash off over time or can be cleaned with efflorescence cleaner. Techo-Bloc accepts no responsibility or liability for this condition.

## POLYMERIC HAZE

Polymeric haze from the use of polymeric joint sand may appear on your concrete products if the sand was not removed from the surface of the paver properly. This does not, in any way, affect the integrity of the product or your installation. The hazing will weather away naturally with time and rain. It can be removed with a specialized cleaner; you are advised to contact your contractor or the polymeric sand company used for instructions and recommendations. Techo-Bloc accepts no responsibility or liability for this occurrence.

## CONSTRUCTION RESIDUE

A by-product of cutting with a saw is residue-filled water or concrete dust. Residue filled water or re-hydrated dust can cling to the surface and leave a concrete stain. It is recommended to wash and remove the water or concrete dust from the surface of the pavers before it dries. Construction residue can also happen through soil disturbance or environmental elements. These contaminants should be removed immediately but do not affect the integrity of the product or your installation. Techo-Bloc accepts no responsibility or liability for these occurrences.

## PROPER COLOR DISTRIBUTION AND LAYING TECHNIQUES

Proper installation enhances the overall color of pavement. Units should be randomly picked from at least two pallets when installing. This creates an attractive and subtle blending of color.

## COMPACTOR AND SNOW REMOVAL EQUIPMENT

Pavers with an embossed surface (high and low points) are more susceptible to scuff marks from vibratory plate compactors used in most concrete paver installations. Techo-Bloc recommends the use of a urethane mat between the plate and the paver surface during compacting. Contact your equipment supplier for more information about accessories for this purpose. Also, snow removal equipment should have the proper spacing, bumpers, and rubber blade guards to protect the surface of the pavers. Techo-Bloc is not responsible for damage caused by the misuse of compaction or snow removal equipment, which may leave scuff marks, or burns on pavers.

### NOTE:

For industry information about efflorescence, polymeric haze or information pertaining to installation specifications, please visit [www.icpi.org](http://www.icpi.org) or [www.ncma.org](http://www.ncma.org).





### LIMITED WARRANTY

The warranty applies to concrete landscaping and masonry products (herein referred to as “products”) intended for residential use and manufactured by the Techo-Bloc group.

All Techo-Bloc products comply with applicable standards established by the American Society for Testing and Materials (ASTM) and the Canadian Standards Association (CSA).

Techo-Bloc offers a transferable life-time warranty on its products, commencing on the date of delivery. The warranty covers the structural integrity of the products and any abnormal deterioration of its surfaces that may be caused by the use of rock salt (sodium chloride [NaCl]) for de-icing pavers, slabs or steps, with the exception of Stonedge collection products, unless otherwise stated.

### THE FOLLOWING CONDITIONS OR EVENTS ARE NOT COVERED BY THE WARRANTY:

1. Claims regarding the color, size, or texture of a product already installed. An installed product confirms the acceptance of the product received.
2. Use of rock salt and transferability of warranty on Stonedge collection products (wet cast products) unless otherwise stated.
3. Splitting, chipping or other breakage caused by impact, abrasion or overloading.
4. Damage or loss caused by the movement or settling of the underlying structure or base components upon which the products are set.
5. Damage or loss caused by design or installation not in compliance with local codes, industry standards or the guidelines provided by the Interlocking Concrete Pavement Institute (ICPI), the National Concrete Masonry Association (NCMA) or Techo-Bloc.
6. Damage or loss caused by natural disaster, including but not limited to, earthquakes, floods or other similar events.
7. Acts of negligence or misuse by the owner, installer or any third party.
8. Color matching to printed representations.
9. Efflorescence, polymeric haze or construction-born residue. (See the important information section for terminologies)
10. Damage or loss caused by the operation of compaction or snow removal equipment.
11. Normal wear and tear and normal behavior, such as variation in colors or shades.

In the event of product failure within the scope of this warranty, Techo-Bloc will replace the affected units only, following a site inspection and assessment of the products by Techo-Bloc or its representatives. Techo-Bloc’s responsibility is limited to the cost of the product only and not to the costs related to the installation or replacement of said products. Techo-Bloc will honor this warranty only with a proof of purchase, such as an invoice or delivery slip.

Care and  
Maintenance



SCAN THE QR CODE OR VISIT  
[WWW.TECHO-BLOC.COM/  
CARE-AND-MAINTENANCE](http://WWW.TECHO-BLOC.COM/CARE-AND-MAINTENANCE)





**FLEXLOCK**  
BY ALLIANCE DESIGNER PRODUCTS

## PROTECT AND ENHANCE YOUR HARDSCAPE INVESTMENT

Flexlock provide a full line of premium-quality jointing components, adhesives, cleaners, protectants, paving-edge systems and geosynthetic structural components – the complete line of innovative hardscaping products.



DISCOVER MORE AT [WWW.TECHO-BLOC.COM/FLEX-LOCK](http://WWW.TECHO-BLOC.COM/FLEX-LOCK)



# Institutional, Commercial & Industrial

## Where design meets durability

With over 35 international patents, we aim to strike the perfect balance of natural hues and incredibly-authentic textures across a diverse range of scale. Discover the widest selection of commercial grade pavements engineered to bring your design to life, even in the harshest environments.

**VISIT [WWW.TECHO-BLOC.COM/SPECIFIER](http://WWW.TECHO-BLOC.COM/SPECIFIER)**





# TECHO — BLOC

INSPIRING ARTSCAPES

